

JAN/FEB '88  
Vol. 4 No. 2  
\$3.00 U.S. Funds

BULK RATE  
U.S. POSTAGE  
PAID  
COLTON, OR 97017  
PERMIT #51

POSTMASTER:  
PLEASE EXPEDITE DELIVERY  
DATED MATERIAL  
ADDRESS CORRECTION REQUESTED

## AMERICA'S LARGEST TIMEX SINCLAIR MAGAZINE

# Time Designs MAGAZINE



BUSINESS  
ISSUE





# FOOTE SOFTWARE

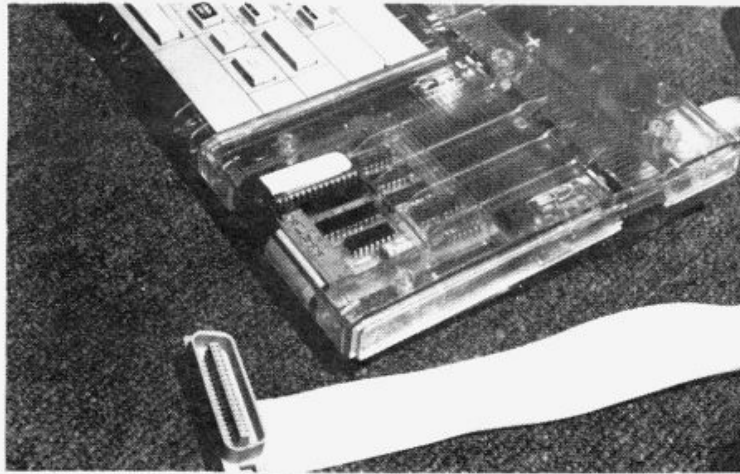

## SPECIAL SHOW PRICE!

### The FOOTE PRINT PRINTER INTERFACE

- for Centronics parallel printers
- works in both 2068 and Spectrum mode
- compatible with OS-64 & Spectrum emulators
- EPROM socket and on/off switch on board
- works with **both** Tasman and Aerco driver software
- plugs into cartridge dock—door completely closes with cable running back under computer
- frees up rear edge connector allowing other peripherals to be used; less chance of a crash
- print driver software for LPRINT, LLIST, and COPY included for 2068 and Spectrum modes

FootePrint Interface w/software & cable **\$39.95**

FootePrint with OS-64 option included **\$60.00**

Bare board & instructions only .....\$20<sup>00</sup>

Cable only for use with bare board .....\$15<sup>00</sup>

Zero Insertion Force Socket option add **\$10**

SOFTWARE	TS2068	TS1000
----------	--------	--------

Badgammon (Backgammon).....	\$12.95	
Advanced Math (Calculus).....	\$12.95	\$7.95
Calorie Counter.....	\$9.95	\$5.95
U.S.A. (Pres. & States & Caps.)....	\$9.95	\$5.95
Gambler (poker).....	\$9.95	
CHR\$ (char. & graphics generator)	\$12.95	
Hangman & TIC-TAC-TOE.....	\$5.95	

Brother M1109 Dot Matrix Printer, compact, low noise, 100 CPS, both Parallel and Serial interfaces, multiple typestyles with near letter quality print mode and 4k memory buffer. comes with tractor feed unit..... **\$249.95**  
 QL or Zebra FDD cable for above: **\$17.00**

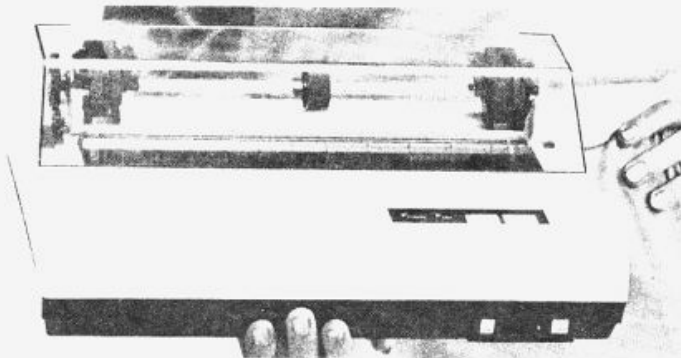

### The Best of SUM

Some sample articles include: Building Your Own Spectrum Emulator, Repairing Your TS-1000, Word Processing Reviews for the 2068, UDGs on the TS-1000, Extensive Review of the Zebra Disk System, Adding a Keyboard to the 2068, and Enhancing the A & J Microdrive. 112 pages

Price: **\$11.95**

### THE BEST OF



for SINCLAIR/TIMEX USERS MAGAZINE



A compilation of the best articles, reviews, programs, and hardware projects

### The Best of SUM, Part II

Articles include Building an EPROM Programmer, Sprites on the 2068, Adding RGB to 2068, QL Word Processing, What's Available for TS-1000, and much more. 60 pages

Price: **\$7.95**

FOOTE SOFTWARE P. O. Box 14655 — Gainesville, FL 32604 904/462-1086 (6 pm - 9 pm EDT)  
 All prices are pre-paid and include shipping charges. Florida residents must add 5% state sales tax.



## Time Designs Magazine Company

29722 Hult Road  
Colton, Oregon 97017  
USA  
(503) 824-2658  
CompuServe ID# 71350,3230

**TIME DESIGNS MAGAZINE** is published bi-monthly and is Copyright 1987 by the Time Designs Magazine Company, Colton, Oregon 97017. All rights reserved. Reproduction of this magazine in whole or in part by any means without written permission is prohibited by law.

**SUBSCRIPTIONS:** \$16.95 a year for six issues (U.S. funds only), mailed in the U.S. No extra charge for Canada or Mexico (mailed "surface" rate). All other countries please write for information on surface and air mail rates.

**CUSTOMER SERVICE:** Customer satisfaction is our goal. For subscription service problems, or any questions and comments, please write or call.

**CHANGE OF ADDRESS:** Please call or write our office if there is any change in your current mailing address to prevent delay or even loss of service. The U.S. Postal Service will not always reliably forward magazines (believe us, not them!). Notify us as soon as you know of any changes.

**RENEWAL TIME?** To determine your expiration date, simply read the date posted in the upper-right corner of your mailing label (magazine cover). For an example, "Nov/89" would indicate that the November/December 1989 issue would be the last issue received. A form is provided elsewhere to renew your subscription. We also send one notice in case you forget. An early renewal is very much appreciated, and let us know we are doing an adequate job.

**DEALERS, HARDWARE/SOFTWARE DEVELOPERS:** Write for our display ad rate card, and find out how you can reach the largest number of Timex Sinclair users in North America.

### TIME DESIGNS is:

Managing Editor: Tim Woods

Assistant Editor: Stephanie Woods

Production Assistants: D. L. Woods  
Don Axmaker  
Kim Axmaker

Photography: (unless otherwise noted)  
Thomas B. Judd

Printing: Al Underberg and Toad'L Litho Printing & Composition, Oregon City, Oregon 97045.

Frequent Contributors: Joe Williamson, Paul Bingham, Wes Brzozowski, Michael E. Carver, Tim Stoddard, Earl V. Dunnington, Syd Wyncoop, Zack Xavier Haquer, Fred Nachbaur, Mike de Sosa, Joe Newman, Stan Lemke, Duncan Teague, Albert F. Rodriguez, Bill Ferreebe, William C. Andrews, Dick Wagner, Dennis Silvestri, Gale Henslee, M. Vincent Lyon, J. Kevin Paulsen, Warren Fricke, Charles E. Goyette, Kenneth Fracchia, Dennis Jurries, Floyd Chrysler, D. Hutchinson, Herb Bowers, Sr., John McMichael, and others.

International Correspondent: R. Lussier

**NOTICE:** Contributors to TIME DESIGNS are independent of the TIME DESIGNS MAGAZINE CO., and opinions expressed in the contents of this publication are not necessarily those of the management staff or its advertisers. Time Designs Magazine Co. will not be held liable for any damage or consequences resulting from instructions, assertions of fact, review of products or companies provided in the magazine's content. It is recommended that anyone attempting to modify their computer or constructing an electrical project should seek help from more knowledgeable individuals.

# JAN/FEB '88

## TIME DESIGNS MAGAZINE

Information for all models of SINCLAIR, TIMEX, and AMSTRAD personal computers. Serving North America and the International community.

### FROM THE EDITOR'S CLUTTERED DESK

Tim Woods

## Telecommunications II

We sure have some sharp reader's out there, and I've heard from more than just one this past month. It clues me in, that folks really read this magazine, and that I'm not pasting up all of these articles just for my health (which isn't the case...ask any sort of magazine or newsletter editor!). What happened was, as the deadline approached the critical stage for the last issue (Nov/Dec), we were still missing some key articles on "TS Telecommunications" (some of our writers were running a bit behind...understandable, since this all took place right around the Holidays), and I had badly miscalculated our available ad space. Not to mention that our printer was patiently waiting, and the magazines had to reach the bulk mail center before Thanksgiving, or delivery before Christmas couldn't be guaranteed.

The result was, after a nightmarish attempt to wrap things up at the last minute, we ended up with much less than the Telecommunications issue we had planned for. And thus, our mailbox was full of good intentioned letters pointing out that "only two and a half articles, does not a theme issue make!".

Exactly so, and we'll try to keep our theme issues more on track. However, included in this issue, the "Business" theme, we are also publishing a few of the articles that were omitted last time. Especially the Serial port printer driver program written by John Bell. This is the long-awaited sequel to an article we ran in the March/April '86 issue. It described how to construct a Serial interface from a surplus Westridge modem board. Now we have the software to really make it fly!

## Computer Graphics

Next issue (March/April '88), will carry the theme of "Computer Graphics". The TS2068 really shines in this area, so look for some interesting articles on such subjects as wire frame graphics, pull down menus, and grey-scale screen copying. And I'll bet that Fred Nachbaur won't let the ZX81/TS1000 go neglected in this area either.

I have an offer for you. If you are a computer artist, here is your chance to be famous. Send us a copy of your original art before the next issue goes to print, and we may use it on the cover or elsewhere in the next issue. If we don't receive anything, we'll be stuck with using some of my artwork on the cover...and I'm not an artist! Come on talented people! In fact, we just might through in some sort of a prize to the best artist, who's creation is selected for the front cover. (Note: please provide us with an original copy or a high quality photo-copy of your art, and let us know which software and equipment was used to produce it.)



**\$289.99**

# THE ULTIMATE SYSTEM

**\$289.99**

AFFORDABLE, FAST, RELIABLE, EASY TO USE and 815k per disk... That's BYTE POWER ULTIMATE DISK SYSTEM for the TS2068!!!

software to get you started!

All this is yours for only \$289.99 (US)

DUAL DRIVE system (same as above but with 2 QUAD density disk drives for a total storage capacity of 1.6 megabytes).....\$375.00

4 Disk drive system available, please write for more information.

PLEASE ADD \$10 for SHIPPING/INSURANCE per system

Comes fully assembled and tested with 90 DAY warranty. This system includes: 1 LARKEN DISK INTERFACE, 1 LKDOS cart. (with EX-BASIC), 1 QUAD density disk drive (815k per disk), DISK CASE, POWER SUPPLY and ALL CABLES.

PLUS you get 1 free box of 10 disks and free

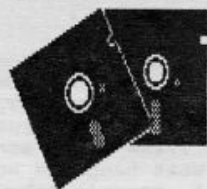

*The D.U.S.*  
Version 2.0

Did you ever lose a program because of a bad disk? Or simply erased the wrong file and could not retrieve it?

Yes? Well this software may be of interest to you then...

This program is not only used to retrieve files, in fact, this package contains 20 DISK UTILITIES!!!

These utilities are... FORMAT DISK, CHANGE DISK LABEL, CHANGE HEAD SPEED, CHANGE NUMBER OF TRACKS, CHANGE NUMBER OF SIDES, RENAME FILE, VALIDATE DISK, CATALOG DISK, COPY ENTIRE DISK, EXTENDED CATALOG (1 FILE), EXTENDED CATALOG (ALL FILES), RECOVER CATALOG, RECOVER ERASED FILE, RECOVER FILES FROM BAD DISK, MOVE FILE, MOVE ALL FILES, ERASE FILE, ERASE ALL FILES, SECTOR EDITOR and SECTOR ANALYZER.

This is the most complete package for the LARKEN system!!!

Available on 5 1/4" disk (Double or QUAD density, specify)

Works on AERCO, RAMEX and OLIGER I/F with LARKEN LKDOS cartridge

**\$29.95 (US) + \$2.00 Postage/Handling**

If purchased with THE ULTIMATE DISK SYSTEM.....only \$24.95 (US)



## 1ST CLASS MAGAZINE

BYTE POWER is a highly sophisticated computerized magazine on cassette for the TS2068 and SINCLAIR SPECTRUM.

No longer will you have to type in long, fastidious programs...JUST LOAD AND RUN!

BYTE POWER is the ULTIMATE magazine, over 100 programs were published up to now (9 issues). Most of these programs are in FAST MACHINE LANGUAGE! And we bring you this quality programming at a very small cost...

...LESS THAN 39 CENTS A PROGRAM! (based on a 12 issue subcr.)

1 ISSUE.....\$5.50      6 ISSUES.....\$29.99  
12 ISSUES.....\$49.99    SAMPLE/CATALOG tape....\$2.00

FIRST CLASS PACK (6 BACK ISSUES IN A VINYL ALBUM).....\$35.00

## BYTE POWER 1st CLASS FONTS

A compilation of all FONCS used in BYTE POWER Magazine...

FUTURISTIC, COMPUTER, THIN, SUPER BOLD, CONTOUR, ITALICS, ARTI-ITALICS, TYPE WRITER, ORIENTAL, ADVENTURE, BALLOON, SMALL TYPE, ARMY STYLE, BOLD ARMY, SMALL BOLD, PLAIN BOLD, and EASY READ.

These fonts are compatible with PIXEL PRINC. Plus you get

**OLD ENGLISH**

and 64 Column Print.

As a BONUS, you also get a FONC EDITOR to create your own character sets!!!

**\$10.00 (US) + \$2.00 S/H**

## THE BANNER PRINTER

Create GIGANTIC banners for special events or just for fun!

Feature over 60 graphic designs + 1 GIGANTIC title font + IBM type font + 1 ADVENTURE font + COMPUTER font + SUPER BOLD font + WRITER'S TYPE font, you also get a GRAPHIC DESIGNER to create your own graphics!

**\$15.95 + \$2.00 S/H**

ALL PRICES IN US FUNDS ONLY.



**1748 Meadowview Avenue**  
**Pickering, Ontario, Canada**  
**L1V 3G8**



# Send In the Clones

This is a subject that I hesitate to tackle, since it opens such a big can of worms. However, due to some recent correspondence, I felt that it was necessary to bring it up.

Some months back, *SYNCHWARE NEWS*, one of the oldest TS publications still around, announced that they would begin to cover information on *IBM PC's and compatibles*. Their decision was a result of a "decreasing subscription base"...and also perhaps because both the editor and publisher have started to tinker with IBM machines.

I don't want to be judgemental about their decision, because sometimes a person (or company) has to do what they must do. Instead, I carefully monitored the reaction to this from our own readers. I heard everything from "did you see what they did, they're just selling the TS computers short!"...to, "I think it's a good idea...I use a TS2068 and a PC clone".

It's easy to see the attraction to the IBM market. Just glance through a recent copy of *COMPUTER SHOPPER*, and you will see a multitude of good bargains. It is the new world standard, and about every new computer to come along can (in some way) utilize PC software and the MS-DOS format.

There are drawbacks too! In many cases, serious software packages for the PC will cost up to twice the amount of what I paid for my entire Timex system. Also the complexity of the computer itself doesn't easily lend itself to the study of basic computer principals and programming... not like our beloved Sinclair computers. Also, if you have been following along with what's going on in the market, you may be aware that IBM itself is trying to shake

up the very market they spawned with newer models that will be basically incompatible with current technology (that's right folks, thousand's of beige-colored orphans!).

This all boils down to just a few points. At this time, I feel that to include IBM information as part of our regular format in *TIME DESIGNS* isn't really necessary. There are already hundreds of *IBM PC publications*, but only a few for the Timex Sinclair.

I do however, feel that it would be beneficial to discuss in *TIME DESIGNS* ways to adapt some of the bargain RAM boards, circuit cards and PC style keyboards. In fact, I recently discussed with Wes Brzowski about this possibility, and he assured me that there are several ways of doing this.

I would also be willing to publish information on interfacing the PC to both the Sinclair QL and the new Cambridge Z88. Perhaps we could even review some of the new PC clones from Amstrad, including their new line of portables. After all, Amstrad owns the QL and Spectrum technology now.

It's true, that many of you use a PC both at home and at work...and I'm sure you could pass along some helpful information to us from time to time. However, to restate our basic philosophy: *TIME DESIGNS* will remain a Sinclair magazine.

We all need to remain *positive!* Indeed we are orphans, but we are also the best-supported orphan brand around. I still enjoy my TS equipment and I still learn new things about it all the time, and hope that you share this same view. I have the feeling that 1988 will be a very good year (remember to think *positive!*).

- Tim Woods

## **\*\*T/S COMPUTER FEST NEWS\*\*** **SUNSTATE WINTERFEST '88 just weeks away.** **Don't Miss Out!!**



SUNSTATE T/S WINTERFEST  
ORLANDO, FLORIDA

Vacation? How about the best of all Worlds!?

Central Florida is one of the most popular vacation spots in America and this spring it will be one better because the next major TS Computerfest will be held there in Orlando, just minutes from Walt Disney World, EPCOT Center, Sea World, Circus World, and most all major attractions of Florida.

The Timex/Sinclair User Group of Florida are presenting the SUNSTATE T/S WINTERFEST '88 this March 4, 5 and 6 in Orlando, at the ORLANDO MARRIOTT on International Drive.

Now is the time to start planning your family vacation for a week or so in this mecca of vacations with the Winterfest weekend as an added bonus to your itinerary. Just imagine, while you take advantage of all the super deals and information available for your computer at the Winterfest, you can send your wife (or husband) and the kids off to Disney World for a day of fun and everyone is happy!

March in central Florida is ideal because it is usually warm enough to swim, yet much cooler than the hot, sticky summer months. The Marriott itself

is providing discount rates for our Winterfest and has excellent facilities with four lighted tennis courts, three large pools, jacuzzi, and child's pool (all heated), health club facilities, three restaurants and five bars.

The meeting rooms are larger than the ones at the last two Midwest Computer Fests with more than enough electrical outlets (this place is used to having computer shows!).

The Orlando Marriott is giving Winterfest goers a "convention rate" of \$90 per night for single and double occupancy, and \$105 per night for triple and quad. We do realize that this is much higher than what everyone is used to paying at previous Fests. But when you consider the locale, it's quite a bargain. These rates will be good for an entire weeks stay. There are other hotels in the area with rates as low as \$75 per night, but you would have to then worry about transportation. When you contact the Marriott to make a reservation, be sure to mention you will be attending the Sunstate T/S Winterfest '88, and that you want the special convention rate. Their number is (305) 351-2420, and they accept all major credit cards.

To help cut costs, we will be trying to match up people who would like to share a room. Please let us know when you register.

Advanced reservations are now being accepted by sending your name(s), address and phone number to:

SUNSTATE T/S WINTERFEST '88

249 N. Harden Ave.

Orange City, Florida 32763

Fees for early reservation are \$5 single, \$9 family. Fees at the door will be \$8 single and \$12 family. Fees for Users Groups having a table at the Fest will be \$10 per table now and \$15 per table at





the door. Be sure and make all checks out to the "Northeast Florida T/S Users Group". We are using their checking account to make things easier as they are one of the host groups.

For more information you can either write to the above address, or call our 24 hour Winterfest BBS, at (904) 775-0093. Settings are 8/1/N (it is a 300 baud board). And you can also call this number from 6-9 pm EST: (904) 462-1086, for further information.

For those who register early, we will be having a drawing to win a free room at the Marriott for one night!

For those people who are planning on flying, we have negotiated with Image International to provide us with the best possible rate from anywhere in the U.S. Travel arrangements can be made by calling 1-(800)-327-1360 outside Florida, or (305)-351-1976 in Florida between 7:30 AM and 7:00 PM EST. Monday through Friday and 9:00 AM to 2:00 PM EST on Saturday. State that you are interested in travel reservations to the Sunstate Timex/Sinclair Winterfest. Also let them know whether you need ground transportation or car rental to get to the Winterfest. Ground transportation will cost an additional \$10 round trip...a real bargain compared to what a taxi would cost!

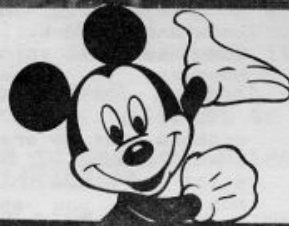

## McBrine Computer Products

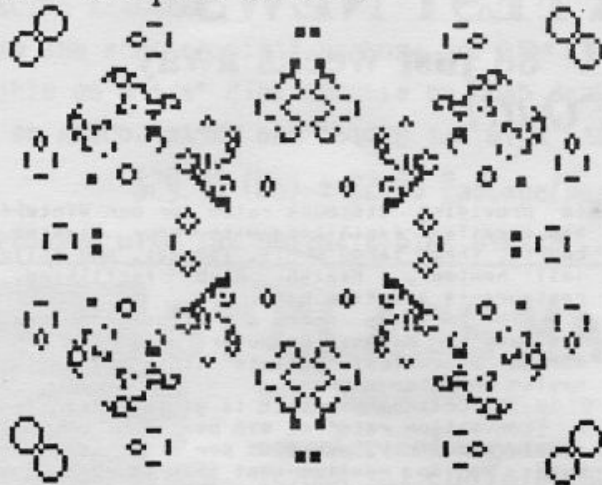

### Software for the TS2068 from McBrine Computer Products

**LIFE for the TS2068 v. 2.0** - See John Conway's revolutionary pattern-generating game for yourself! 3 times as fast as our original; includes 24 x 32, 48 x 64, and now 96 x 128 in one program, plus saving & loading and an improved keyboard routine. Free to owners of the original. (Coming soon - TS1000 and QL versions!).....\$9.95

**POWER PRINT** - The ultimate in support for your Epson-compatible printer with Aerco, Tasman, or A&J interface. Features: 100% correct LLISTings & Accurate aspect-ratio b/w screen dumps in 2 sizes & text-only screen dumps for speed & Print to memory & Interrupt-driven print spooler (like having a buffer in software!) & Screen dumps work in 64-col. mode (e.g. OS-64) & TOTALLY RELOCATABLE! & Specify interface and printer. (Will customize for your printer; send print code data.).....\$9.95

**DRAW 512** - Works in both 256 x 192 and 512 x 192, b/w only. Draw (w/ OVER or INVERSE) & Rotate screen in 4 directions, a pixel at a time & Flip left/right or up/down & Mirror 4 ways & Convert back and forth between 32-col. and 64-col. modes in several ways & Use joystick or keyboard & Screen dumps from POWER PRINT.....\$9.95

**SUPERTOOLS** - Remkill & Header reader & Renumber (with 60 TO's and -SUB's) & Variable dump & Program tracer & All RELOCATABLE except tracer, partly relocatable..\$9.95

Postage paid on all orders  
Send LSASE for FREE catalog!

514 S. Jackson St. & Salisbury, NC 28144  
(704) 633-7817 2-5pm Mon-Th



Some of the planned activities include seminars covering hopefully all aspects of our computers, a swap room, minor repairs to computers and interfaces. We will have available replacement (new) TS1500's and 2068's, as well as replacement SCLD's for both! There will be a cocktail party with finger foods Friday night (March 4) from 8:00-11:00 PM, and everyone is invited. Cost for the party is \$10 per person payable at the door. The official hours of the Winterfest are Saturday, March 5, 9:00 AM to 6:00 PM, and Sunday, March 6, 9:00 AM to 3:00 PM. Registration will start on Friday, March 4, at 12 noon.

Because of the international draw of the area, we expect to have both international users and vendors participating at the Winterfest. We have already contacted several with favorable responses. Those vendors we already have commitments from include:

A+ Computer Response  
 AERCO  
 AFR Software  
 Clifford & Grey Computer Products  
 Curry Computer  
 Foote Software  
 Gulf Micro Computing  
 John Olinger Co.  
 Knighted Computer  
 Larken Electronics  
 Markel Enterprises  
 Quantum Computing  
 Quantum Levels  
 RMG Enterprises  
 Sharp's Inc.  
 Syncware News  
 Time Designs Magazine  
 Variety Sales  
 Zebra Systems, Inc.

We also plan to have several local surplus electronics stores with disk drives, power supplies, cables, etc. available for sale.

To The Left: is a picture of our "committee" which includes members of the Northeast Florida T/S Users Group (Jacksonville), T/S Users of Gainesville (TUG), T/S Users Group of Orlando, and the TASBAM group (Tampa And Suncoast Bay Area Microcomputer).

Start planning now for the vacation of your life! If you need more information, please contact the Winterfest BBS, or write to the address above. See you there!

- Joe Williamson

*Don't Miss The  
T/S Event Of The Year!*

*Airline Rates  
Are Very Low Right Now!*

**Walt Disney World®**

**SUNSTATE T/S WINTERFEST '88**  
**MARCH 4, 5, 6, 1988**  
**ORLANDO, FLORIDA**

*Join The Party!*

*Don't Miss Out  
On The Bargains!*

## New Items

### 256K RAM IS READY FOR TS2068

Perhaps the best news to top off our list for 1988 is that Larry Kenny has decided to go ahead and manufacture his 256K RAMDISK expansion system for the TS2068. By the time you read this, it will be available for shipping. A package that consists of a memory board with 64K RAM, and the LKDOS Ex-BASIC Cartridge, is priced at \$129.95 (+ \$5 shipping). Other package plans are available, including one with the popular LARKEN Floppy Disk Drive System. Only 64K RAM is initially supplied, to keep the customer pricing down. As the user's wallet increases, so can the RAM chips, up to a maximum of 256K. The Larken Cartridge contains all of the Ramdisk commands, which are basically equivalent to standard cassette/disk commands. Actually, a Ramdisk works just like an "electronic" tape or disk drive, only much faster. The Larken Ramdisk is also backed-up by battery, and for further safe-keeping of your data, a tape backup program is included. This new Ramdisk might be considered the "poor TS2068 owner's disk drive system", but most wealthy owner's will want one of these too! For further info: Larken Electronics, RR#2 Navan, Ontario, Canada K4B-1H9.

### HOT NEW PC BOARD DESIGNER

This new TS2068/Spectrum software package has a professional touch, from it's packaging to the detailed and thoughtful User Guide. PC-DRAW VERSION 3.0 is the latest from a new company called M.D.M. Enterprises. PC-DRAW is a tool that, with a little practice, will design highly-detailed drawings of printed circuit boards suitable for photographing (providing a negative for circuit board etching). Version 3.0 is an improved descendant of version 2.0, which was briefly released last year. Mike Davis, of M.D.M Enterprises, told TDM that owner's of Ver.2.0 can upgrade to 3.0 by sending \$7.00 to: Mike Davis, 706 S. Mason, Saginaw, MI 48602. Interested TS2068/Spectrum users can send a S.A.S.E. to the address above for a list of TS dealers who carry the new Ver.3.0. It is priced at \$19.95. M.D.M. is only a software developer and distributor. They only wish to sell the program through dealers.

If you are interested in developing circuit boards like the example below, with your home computer and a high-quality dot matrix printer, then give your favorite TS dealer a call. Chances are, when the word gets around about this one, he just might be "sold out"!

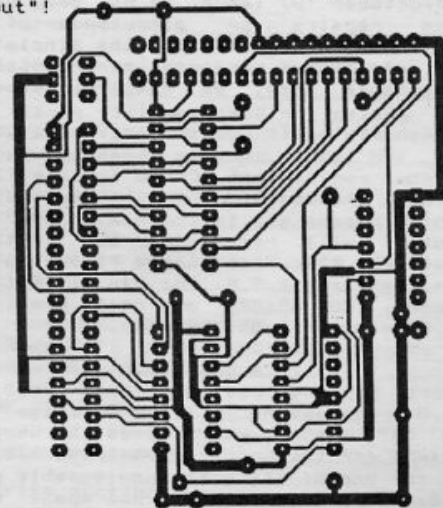

### WEAK DOLLAR FORCES COMPUTER PRICES UP

If you have looked up from your computer monitor lately and turned towards the evening news, you may have noticed what the stock market, the deficit, and the slow-growing economy, has done to the U.S. dollar overseas. Especially in Europe, the homeland of our Sinclair computers, and still the provider of many hardware and software items purchased here in the States. As of this writing, the British Sterling Pound fluctuated sharply



between 1.84 and 1.88 equivalent U.S. dollars on the international currency exchange. No significant improvement is forecasted at this time.

What does this mean? Well, checking with the two dealers most involved in importing computer goods from the U.K., Sharp's Inc. and Curry Computer...prices are indeed going up. For example, interfaces for the Sinclair QL (like the Trump Card from Miracle Systems) have raised 10%. Sharp's, Inc. was forced to raise the price on the new Cambridge Z88 laptop to \$479.95, since previous stock was purchased before the last big drop of the dollar.

It's possible that sales of home-brew Sinclair hardware and software support may show a significant surge. While the number of independants who develop after-market items don't even come close to their counterparts in the U.K., there is still a talented force out there who could produce, if called upon.

#### UPDATED TAX SOFTWARE...JUST IN TIME!

If your play'n and singing the "tax reform blues" this spring, you just might need some accompaniment from one of the two tax software packages released just in the nick of time.

GWIK-1040 from Herb Bowers, Sr (ABBA SOFT) is for the TS2068 and covers just about any common 1987 Federal Tax form and schedule, with over 80K of data in two parts. Herb Bowers, a former Federal auditor, has a real knack at explaining the tax code, and his comprehensive programs pack a lot of extra's. Quick First Class delivery is promised for \$29.50 postage paid on cassette tape. Write to: 2588 Woodshire Circle, Chesapeake, VA 23323.

QL users, TAX-I-QL/87 will help! Peter Hale of EMSOFT has devised a template for use with Psion's ABACUS (QLSS) spreadsheet which will aid in the filing of Form 1040 and associated schedules and forms. 256K RAM is required, and there is a standard version on Microdrive cartridge, and a disk version which actually prints to the IRS forms (just like the big guys!). Price for the package (either version) is \$24.95 from: EMSOFT, PO Box 8763, Boston, MA 02114.

#### DAN THE "REPAIR GUY"

Is what one of our reader's kindly referred to Dan Elliott, of Promise Land Electronics, as. Since we first discovered and reported on Dan in our September/October '87 issue, he has been fairly busy performing repairs on all types of Sinclair equipment. And now he has added the Sinclair QL to the list of popular microcomputers he will service for a reasonable rate. We have received several notes of praise for Dan's quality repair work, and want to wish him continued success. On a side note, Dan told TDM that he has been having trouble tracking down replacement SCLD's for the TS2068. If anyone has knowledge of where to obtain this custom chip, please get in touch with him. A number of computers will remain on the "critical list" without it. For a service charge rate sheet or other inquiries, send a S.A.S.E. to: Dan Elliott, Rt 1 Box 117, Cabool, MO 65689, or call evenings (314) 739-1712, Sunday through Thursday.

#### BETA BASIC 3.0

Robert Hartung reviewed the excellent BETA BASIC 3.0 programming utility package in the May/June '87 issue, which gives the user over 100 new commands for the Spectrum/emulated TS2068. Mr. Hartung is one of the most knowledgeable proponents of Beta Basic in the U.S., and has spent much time in writing about it's virtues. To quote from the TDM article, "...after a year of learning my way around it a bit I am even more convinced that it provides our "toy" computers with what it probably the most powerful BASIC programming language available on any 8-bit micro today."

Robert Hartung has just sent us an update on Beta Basic: Andy Wright (the head of BetaSoft and author of the program) informs me they have moved. MasterCard or VISA orders for Beta Basic should be sent to the new address- BetaSoft, 24 Wyche Avenue, Kings Heath, Birmingham, B14 6LQ, England. Both Beta Basic 4.0 with RAMdisk features for the 128K Spectrum, and Beta Basic 3.0 for the 48K Spectrum (and TS2068), are supplied on the same tape for 15.95 British pounds ppd. Beta Basic 3.0 alone is about \$1.00 less.

"After playing with a QL for awhile, even with Super Toolkit II added, I still believe Beta Basic is far more "user-friendly" than SuperBASIC in its syntax and ease of access to most of the comparable programming features, especially when used with my Oliger DOS."

#### ADD THESE BBS #'s TO YOUR LIST

Fred Nachbaur of Silicon Mtn. Computers, has been working overtime for users of the TS1000/ZX81. This time he has managed to secure space on a sub-board of the Nicolson Nighttime Network, in Nelson, British Columbia, and has appropriately named it the ZX TERM EXCHANGE. The BBS phone number is (604) 354-4666. Settings are 8/1/N (300 baud). After you logon, go to SIG 3. Fred reported that there are currently 20 programs to download, along with a TS message base.

James Rodlin is SYSOP of the TIMEWARP BBS, a 24 hour, all Sinclair board, located in the Boston area. The phone number is (617) 481-0555. Settings are 8/1/N (300 baud). James has some plans for the BBS..."I will be upgrading to 1200 baud once TMX-64 is released. There are currently eight sub-boards, and more will be coming once I get more disk drives for my system (the new Larken DOS). I use the TS1000, TS2068, Spectrum, and QL." Why don't you give the TIMEWARP a try?

#### SINCLAIR ON THE AIR

If you happen to live in the southern part of Texas you may be surprised to hear what's going over the airwaves on AM radio. "The Computer Show" is a popular feature on Saturday afternoon's at WOAI Radio in San Antonio, Texas. While the "question and answer" format of the two hour talk show is geared more towards the IBM PC market, from time to time, special spots have been given to other computer models, including Sinclair. WOAI programming director, John Stewart, is responsible for the format of the show. He is also a Sinclair user, and owns both a ZX81 and a QL. Recently, spots have been

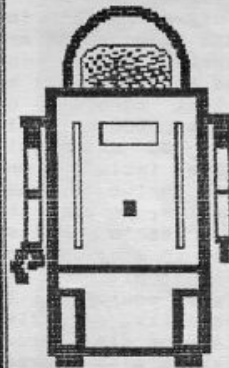

#### LEARN BY DOING

Want to do something unusual with your ZX81 or TS1000? Would you like to control a personal robot? You can control an ultrasonic range finder with your computer.

We have a "How To" book that details these fascinating projects.

We've got circuit boards and kits supporting the projects.

Need spare parts to repair your ZX81 or TS1000?

We've got these parts too!

Send for free price list to:

BUDGET ROBOTICS &  
COMPUTING, INC.  
BOX 18616  
TUCSON, AZ 85731



given to the high-resolution software from Fred Nachbaur of Silicon Mountain Computers (and TDM contributor), and also the Sinclair QL. In fact, a QL purchased from Sharp's Inc. sits in the control room at the station. Stewart claims that whenever the information on Sinclair or Timex/Sinclair has been presented, the response has ranged from favorable to that of genuine surprise. A lot of our the listners have a TS1000 or ZX81 tucked away in a closet, and aren't aware there is still support.

#### TS2068 COMPUTERFACTS

Last year at the TS Fest in Indianapolis, a representative from the Howard W. Sams Co. discussed the possibility of a Sams Computerfact for the Timex Sinclair 2068, with TDM editor, Tim Woods. Computerfacts are special information packets that provide technical data to service professionals. There is already a packet for the TS1000/ZX81. The TS2068 Computerfact has just been released. Both packets list for \$19.95 each. For more info, contact your local Sams dealer, or call (800) 428-7267.

#### NEW 2068/SPECTRUM SOFTWARE

Dr. Faisal El-Shoufy, is Director of the Computer Training Center in New Iberia, Louisiana, and has just completed programming five new arcade games that will be marketed for the Spectrum in Europe, but also will run on the stock TS2068 without any software or hardware modification.

The new titles include: WitchiGlenda (\$8.50), Gulf War (\$8.50), Rotten Tooten (\$8.50), Knight & Goblins (\$10.50), and Moon Fight (\$9.50). The games are reported to contain high resolution colorful graphics, well-designed sprites, and excellent sound effects. Prices quoted above are for cassette tape and include postage. Shortly, versions will be released on disk for Disciple users, and on wafer for Rotronics users. Write to: Computer Training Center of New Iberia, 525 E. Main St., Suite 5, New Iberia, LA 70560.

#### PLANNING MEETING

On January 30, 1988, there will be a Midwest User Group meeting at the Linden Library in Columbus, Ohio, from 1:30 to 5:30 PM. The purpose of the meeting is to look at the possibility of another Midwest Fest. A tour of CompuServe headquarters is also slated. If interested, contact: Mowgli Assor, 2000 Elmwood Ave., Apt. B, Columbus, OH 43212.

#### WEST COAST FAIR PLANNED

The CCAT/S User Group of Oregon is the host group for the Third Annual International/Great NW Timex Sinclair Mini-Fair. Since the San Francisco Fest was scrapped, the planning committee has decided to run the fair for two days and open the event up to the whole west coast (or anyone for that matter). Tentative date for the Mini-Fair is the second or third week of August, 1988. A suitable site is currently being selected in the Portland, Oregon Metropolitan Area. The planning committee is also placing emphasis on the whole family, and will have many activities for non-computer enthusiasts. The RMG BBS at (503) 656-8072 is the official Fair BBS and clearing house for info regarding the upcoming event (settings are 8/1/N, and is operated through the evening hours and early morning). Start planning your summer vacation for the Great Northwest.

#### PIXEL PRINT PLUS

Stan Lemke informed TDM, that after a year on the market, he has upgraded his popular Desktop Publishing software for the TS2068. PIXEL PRINT PLUS offers ten new features, yet is 100% compatible with all the old ICONS, FONTS and files created with Ver.2.0, and also still works with the TASWORD conversion utility. Stan has also written a new User Guide to accommodate the newest version, and even provides printer POKE's for nine varieties of printers. Also in the works is an all new disk version of PIXEL PRINT for the Larken and Aerco disk drive systems. For further information write: Lemke Software Development, 2144 White Oak, Wichita, KS 67207.

#### CATALOGS TO WRITE FOR

Group Technology, Ltd., 6925 Dogwood Road, Baltimore, Maryland, 21207. Offers a catalog containing some TS items, and many other products

suitable for any computer. Strong on books, and hardware experimentation.

Frank Lockhart, P.O. Box 1131, Shelby, NC 28250, will send a free listing of available software for the TS1000, TS2068, and Sinclair QL, in exchange for a S.A.S.E. Mr. Lockhart has programs for engineering, mathematics, and some games.

## Reader Survey

This data will be collected, and will serve two purposes; a) to plan the format of future TDM issues and b) to supply our advertisers with information about what you might like to see developed, and what you would most likely purchase. The name and address portion is optional. We want to hear from you!!

READER SURVEY  
TIME DESIGNS MAGAZINE CO.  
29722 Hult Rd.  
Colton, Oregon 97017

#### \*ABOUT YOU\*

Name (optional): \_\_\_\_\_

Address (optional): \_\_\_\_\_

Age: \_\_\_\_\_ Male/Female: \_\_\_\_\_

Occupation: \_\_\_\_\_

What is your hobby: \_\_\_\_\_

#### \*ABOUT YOUR EQUIPMENT\*

Computer you use the most: \_\_\_\_\_

Other computers you own: \_\_\_\_\_

What printer(s) do you own: \_\_\_\_\_

What medium do you use to store data? \_\_\_\_\_

What monitor(s) do you use: \_\_\_\_\_

Other equipment you own: \_\_\_\_\_

Software package you use most: \_\_\_\_\_

Other software you use: \_\_\_\_\_

What computer/hardware item are you planning on purchasing this year: \_\_\_\_\_

What software package are you planning on purchasing this year: \_\_\_\_\_

What hardware would you like to see developed for your computer: \_\_\_\_\_

What software would you like to see developed for your computer: \_\_\_\_\_

What one comment would you like to make about TS dealers and vendors (about service, advise, a gripe, a compliment, etc.): \_\_\_\_\_

#### \*ABOUT TIME DESIGNS\*

Most favorite section: \_\_\_\_\_

Least favorite section: \_\_\_\_\_

One particular article/program you really liked in a recent issue: \_\_\_\_\_

If you could make one comment directly to the editor, what would it be: \_\_\_\_\_

Article/program you would like to see in an upcoming issue: \_\_\_\_\_

Suggestion of a topic for a "theme issue": \_\_\_\_\_

Do you know of any TS users who don't receive TDM? Would you be willing to supply their names and addresses? Do you have a suggestion on how we could gain more subscribers? \_\_\_\_\_



# Announcing: A Brand New Publication

## The Sinclair Survivalist HANDBOOK

AVAILABLE MARCH 1, 1988!!

ONLY  
\$10.00

Published by The Time Designs Magazine Co.

*This new book is filled with previously un-published articles and programs from the writer's of TIME DESIGNS MAGAZINE, for the TS1000/ZX81, TS1500, TS2068, Sinclair QL, and Z88 computers.*

**DON'T  
MISS OUT!**

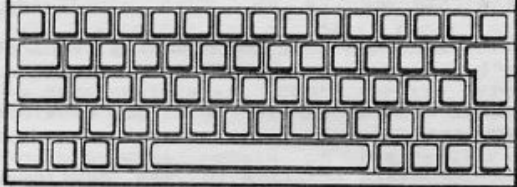

## Subscribe Today

only \$16.95  
year

**TIME DESIGNS MAGAZINE CO.**  
29722 Hult Rd., Colton, OR 97017

New subscription     Renewal

Name \_\_\_\_\_

Address \_\_\_\_\_

City \_\_\_\_\_

State \_\_\_\_\_ Zip \_\_\_\_\_

# TS Communique

Joe Williamson



TS COMMUNIQUE: A forum for people having problems with their Timex Sinclair 1000, 1500, and 2068. If you have any questions, send them to:

TS COMMUNIQUE  
c/o Time Designs  
29722 Hult Rd.  
Colton, OR 97017

I have a Larken cartridge which has a Spectrum ROM, which is activated by the command: OUT 244,3. Is it possible to program a 32K EPROM which contains both the Spectrum operating system and a 64 column operating system, and have them selected by a simple switch? Both operate in the 0-16384 memory region (switch selects one part of the EPROM, while the other part stays inactive).

Renato Zannese  
Toronto, Canada

Dear Renato,

The answer is yes. To carry it even further, why not program a 64K EPROM to contain the 2068 operating system, the Spectrum operating system, and OS-64, each in its own 16K chunk. The advantages include putting the one EPROM inside the machine, freeing up the cartridge space for your own programs, and it would also cut down on "buss loading" by having fewer components loading down the data and address lines.

This has actually been on my "drawing board" for quite some time, but I have been waiting for the price of 64K EPROMs to come down. Because of the weakening dollar, they have actually gone up in price (about \$15 from Jameco), but I guess I will have to go ahead and spring for one now that you have inspired me to look at it again.

The hardest part is programming the EPROM, but if you can handle that, it is mainly a matter of inserting the new EPROM into a modified socket inside the 2068, taking care of two extra control lines (because its an EPROM), and connecting address lines 14 and 15 of the EPROM thru a dip switch to select one of the four 16K areas:

	address lines		
	14	15	
0-16K	low	low	2068 system
16-32K	high	low	your own system
32-48K	low	high	OS-64
48K-64K	high	high	Spectrum

Because you are selecting the upper two address lines, the 2068 will only see that one 16K chunk. Look for a project on doing this in a future issue of Time Designs. While you are at it, why not add 32K of RAM (one chip) to the system by piggy-backing one of the two ROMs (or EPROMs) to a 43256 (32K X 8 Static RAM)? The pin-outs are the same! -Joe

I have an Amdek Amdisk III(B). Sometimes when first turned on and commanded to LOAD from drive #2, it will give a report: V RECORD NOT FOUND,0:2. Or it will load and after working on a program and then going to a line number in the program to save, the

report given is, V RECORD NOT FOUND, 9999:3. This will also happen using a direct command to save. Is this caused by the drive or the disk? If it is the drive, can it be corrected?

Herbert Braun  
Wickliffe, Ohio

Dear Herbert,

I also have an Amdisk III and have noticed the same problem, but only during the first minute or so after being turned on. You mentioned that it does it on drive #2. Are you powering your disk controller from the power supply of drive #2? If so, this may be where your problem is stemming from...as that was causing my problem, but only for a short while after power up.

You may want to try adding some tantalum capacitors to the 5 and 12 volt supply at the controller if it is being run from the Amdisk. Try 1 to 5 microFarads rated at better than 12 volts, and watch the polarity as they have been known to explode when connected backwards. If you don't have the controller running off the Amdisk power supply, try cleaning the heads. If that doesn't work, you may have to have the heads aligned, which would probably require you to send it off to Amdek. -Joe

I recently converted a surplus TI keyboard for use with my TS1000. Everything works OK except for the shifted functions on the "s" and "d" keys. Unfortunately, these include LPRINT and SLOW, which limits the usefulness of the mod. These functions work fine when the add-on keyboard is unplugged. The letters and unshifted functions work as advertised.

I read a piece in an old issue of SYNC, which indicated that the problem could be high resistance in the KB lines. However, I checked the KB1, KB2, and D4 lines with a multimeter and the resistance didn't seem to be any higher than on any of the other lines. The problem in the SYNC article was not with an add-on keyboard, but with the keyboard resistor pack RP-3, and author Stephen Turner suggested solving it by wiring in parallel resistors (to RP-3) on the underside of the keyboard to reduce the total resistance. Would this be worth a try or is there a better solution?

Bob Johnson  
Ypsilanti, Michigan

Dear Bob,

When using an external keyboard, make sure that the internal keyboard is disconnected. Also, the length of the cable that connects the external keyboard to the TS1000 may be too long...don't go any longer than 8-10 inches. It really depends on the type of cable you are using. I would suggest ribbon cable using every other wire, with the ones in-between being grounded. Also try disconnecting any peripherals you have plugged in...see where the problem is actually occurring.

If all this doesn't work, then try adding a 10K to 18K resistor between address line 8 and +5 volts, and address line 9 and +5 volts. If you have access to an oscilloscope, take a look at the address and keyboard lines going to the external keyboard. You should see a waveform swinging from about .5 volts to around 4.5 volts. By probing around, you can quickly determine where enough "signal" is or isn't. If you still have problems, you may need to buffer the external keyboard (see Tim Stoddard's article in July/August '86 issue of TDM), or make your own external keyboard interface which would plug onto the rear edge connector. Back issues of all the TS mags have had articles on this. -Joe

This concerns the inability of the TS2040 printer to print with linearity. The height is greater than the width. Is there a circuit modification that would alleviate this problem? Through the years, I have seen this question asked many times, but never answered.

Jim Powell  
Napa, California

Dear Jim,

I have never seen any modification to cure that problem. I'm afraid that its more the mechanics of the printer (the way the motor "steps" through each bit line). Has anyone out there found a cure for it? -Joe

The cable on the TS2040 printer is extremely short, so I cut mine in half and wired on a male and female "D" connector to the ends. When plugged together, the printer works fine, but when I insert a three foot long cable with matching connectors that I made up, I am unable to even get the "K" cursor on the monitor screen. I have checked the shielded extension cable but found nothing wrong. I would appreciate any suggestions you may have.

Arnold Nieuwenhoff  
Sutton, Massachusetts

Dear Arnold,

The length of the cable is the problem. Too much stray capacitance and inductance is loading down the data and control lines. The 2040 printer is talked to through port 251 (FB hex), but only address lines A2, A7 and control line IORQ are used for decoding through the 74LS10 IC chip inside the 2040 interface. The strobe line out from pin 6 of the 74LS10 can be used to toggle a buffer IC such as a 74LS245 (octal bus transceiver). The other lines used are D0, D2, D4, D7, RD, and WR...plenty of room.

Some extra circuitry will be required to enable and control direction of the 74LS245 using IORQ, WR, and RD. With this buffer added, the TS1000 or 2068 bus is isolated from the long run to the printer and should thus cure your problem. Someone in my user's group did this several years ago and had great results. -Joe

I have a 2068 and purchased the program called "TOMAHAWK". It is a fun program. However, since I also have the RAMEX disc drive system, I'd like to convert it to disc. Here lies my problem: I've been able to save other purchased programs to disc, but this one's got me short of POKEing #'s to addresses, I know very little about machine code. Could you help me out? I'm getting tired of growing a beard every time I want to LOAD this program from tape.

Regis Giacobbe  
Ocean City, Maryland

Dear Regis,

The easiest way to save it is to have an NMI SAVE button on your interface. But since you don't, you need to first be able to break into the program. I'm afraid that I don't have a copy to try, but you may want to try turning on the 2068 and MERGEing in the loader part of the program so you can LIST it and see how the rest of it is loaded. There may be several loading sequences, so you may have to MERGE several times, but always make sure the 2068 is clear of any other programs.

If you can get into the loader program but can't tell how long the code is that is ultimately LOADED in, and you don't have any type of header reader, find out how much memory is FREE and subtract it from 65535. Then try loading the code followed by an immediate save using the result from above for the starting point, and the FREE amount for the length. You may SAVE more than you need, but you will have it all.

This is all provided that you can successfully list the program's BASIC part. Some programs use their own LOADING routines which just simply can't be broken into. I have "Ghost Busters" which is like that, and unless you have NMI SAVE, you can't break into it! Good Luck! -Joe



## Battle Zone

This bit of news from our friends "down under", may come as a surprise...yet will bring a sense of pride to anyone who possesses the mighty silver one...the TS2068.

The Australian Army uses the Timex Sinclair 2068 as part of an inexpensive simulator used to teach soldiers the skills of calling fire from an artillery battery or mortar platoon onto targets in the field.



According to Staff Officer J. Todd, the Timex computers used are standard production models (unmodified), and are interfaced to video projectors that accept the NTSC-type (U.S. standard) synchronization signals. Since the electricity supply in Australia is 240 volts AC, a different transformer is used than those supplied with the stock TS2068.

The Australian Army has made good use of a reliable, yet cost effective computer, as a battle field simulator. The software was developed in the Science Department of the 1st Division Headquarters. The Australian Army works with only a fraction of the budget that the U.S. Army does, but of course, one probably wouldn't find a TS2068 driven simulator in the U.S. military...or would we?

## Bath Boutique

David Lebowitz is very familiar with the use of a Timex/Sinclair computer in a business setting.

"I use a TS2068 equipped with Rotronics Wafadrive and an inexpensive dot matrix printer in almost every phase of running a retail business. In my case, the business is a Bath Botique that my wife and I have owned and operated for about twelve years. We sell accessories for the bath of every description, from shower curtains, rugs and towels to soaps, soap dishes, wastebaskets and upholstered toilet seats. It's a small business that employs eight people, operates from about 3,000 square feet of space and remarkably purchases from a list of over 300 vendors. We are firm believers in offering a broad selection of merchandise and may have one of the most comprehensive inventories of its kind in the Nation."

"Our TS2068 gets used all day long for all kinds of purposes; cash accounting, sales analysis, payroll, accounts receivable, accounts payable, inventory control, purchasing, and of course, word processing. I wrote all of the programs that we use in BASIC (mostly on the TS1000 originally) and continue to update and expand upon them as necessary."

The Bath Botique uses five programs with the TS2068:

**DAILY-** This program provides the input for most of the bookkeeping needs. It is a daily compilation of many of the financial activities, like total cash sales, credit card sales, lay-a-way payments received, refunds and other kinds of cash payouts. The program prints out a daily sheet form and totals receipts and expenses, subtracting the latter from the former. It also performs other functions including a spreadsheet print out at the end of each month, detailing in column form (with monthly totals) each of the various categories.

**CHARGES-** Takes data from the DAILY program that concerns accounts receivable transactions and creates a printout of that month's A/R activities.

It also prints out statements for all active accounts that have other than a zero balance. The statements are produced on continuous forms and just have to be put into window envelopes for mailing.

**CHECKS-** This is the "input" program for accounts payable. Essentially, the program asks for all of the information required to prepare a check. Then it proceeds to actually print out the check using continuous check forms. Among other functions, it prints out a remittance stub that details the payment for the payee, and also maintains a running bank balance at all times and compares monthly deposits to date with withdrawals. Finally, at the end of each month, it performs a sort by account code and prints out a list of all accounts by name, number and total for each month.

**PAYROLL-** This program simply asks for the number of each employee and the number of hours worked. It then calculates gross pay, Federal Withholding Tax, State Tax, FICA deduction and net pay. The data can then be moved to CHECKS, to create payroll checks. PAYROLL also prints out quarterly reports listing each weeks' payroll by employee, quarterly and year-to-date totals for each category mentioned above.

**STOCK-** The hardest working program of all, as it is a combination inventory/ordering program that starts as a pre-printed inventory sheet for all of the items normally carried from a particular supplier and ends up as a neatly printed, fully documented purchase order, extended and totalled (thus providing a comparison figure between invoice totals and purchase orders). The program can also be used to print retail price labels showing item number, name and price for each item ordered. Additionally, the program order data can be saved so that, if additional orders must be placed before this merchandise is received, items on order can be automatically added to the on-hand inventory before the new order is printed.

"I really believe that a computer like the TS2068 is capable of undertaking most of the essential tasks that a small business requires," states Lebowitz. "It does take a lot of patient programming because to be really effective, the programs should be custom tailored to the individual task...of course, that's part of the beauty of simple-to-program computers like ours!"

"I'd be glad to share any further information, including actual programs and/or printouts from them. And I almost forgot...if anyone out there needs any bathroom accessories, I'll be happy to help with that, too!"

Write to: David Lebowitz, 934 Gardner Road, Flossmoor, Illinois, 60422.

## Green Thumb

Out in rural, western Oregon, the climate and soil is ideal for raising an abundance of greenery, and the Independence Nursery (in Independence, Oregon), owned and operated by Marylou Matteo, is no exception.

"I use a TS2068 for my business," states Matteo. "Using OMNICALC, I keep track of plants sold by amounts and dollars brought in from all sales, along with where it went to. During our season, spring, I update weekly or every other week. The 'plants sold' file has 72 customer accounts."

"At the end of each month or so, I print a hard copy and erase the oldest entries so that the data will fit in the computer. The program totals, sub-totals, etc., so that I know how much money came in daily, weekly, monthly and by the season. I also know how many dollars worth of any particular plant sold and when it moved."

"Using MSCRIPT, I do 'help sheets' for customers on a variety of plants, to save time telling people how to grow them, where to plant, etc...which they will not remember when they leave

the nursery. I also do a newsletter that goes out 5 times a year. The print shop prints the newsletter from my copy (created by MSCRIPT), and we put on the address labels made with VU FILE."

Spring is coming around the bend, and Marylou will be busy again. Here's to another successful season and a reliable 2068.

## Engineering

Mel Routt is a familiar name among members of the TASBAM computer group in the west coast area of Florida, of which he was associated with in the early days of its inception. But Mel is also a businessman now president of H.E. Johnson & Associates, Inc. Their major product is power transformers.

"In 1980 I bought my first Sinclair computer, a ZX-80," Mel related. "By 1985 I had learned enough about the little device to package it permanently in a distinctive metal cabinet along with a built in power supply, additional 16K of memory, an interface circuit for the cassette input (ZX-80's were bad to work with most recorders), and a new keyboard by EZ-Key. I finally had a truly functional and 'comfortable' Sinclair computer."

"It wasn't long after that I evolved my first major program that has been used since 1985 to design our products. The program takes our client's requirements in an input mode, churns them around against various calculations used in our industry as well as any special factors evolved from our company's experience and then provides us with the necessary information to fabricate the device. The output has been both screen display as well as the remarkably utilitarian TS2040 thermal printer."

"However, once I acquired a TS2068 computer, and spent some time learning its additional power, the program was upgraded to utilize the new capabilities. The software now provides an estimate of physical size and weight of the finished product. Since I became president of the company I have not had as much time to do the programming I would like to do, but at first opportunity I intend to have the program also compute a cost estimate...all in good time."

Since Mel assumed leadership of the company, he has discovered a multitude of uses for the TS2068, including a calculator to monitor copper base fluctuations occurring almost weekly from all suppliers, and a data base to keep track of accounts, expenses and costs of material, payroll, etc.

"As my CPA says, 'you have evolved the fundamentals of a general ledger'. It also became necessary to operate the program through a full size printer because the data tables are easier to handle on conventional 8 1/2 x 11 sheets as opposed to twenty miles of thermal printouts. Thus I upgraded my system with a daisy wheel printer using an Aerco interface."

"The other major application is the use of the TS2068 with the MSCRIPT wordprocessing program to handle correspondence."

As an update, Mel has had to turn over all accounting to his CPA, since the work load has increased. He is also contemplating on purchasing some PC equipment to meet larger memory requirements, and the Timex system, of which he is very satisfied with, will become a dedicated word processor in the office.

## Stocks

George Mockridge is a friendly, down-to-earth type person, who doesn't mind discussing Sinclair computers. He is active in TS user groups in the San Francisco bay area and former editor of the TIMELINEZ newsletter. And he also applies his Timex computer in a demanding business...the stock market.

George first started keeping track of statistics and stock market calculations using a programmable TI calculator. His next step was to purchase a Sinclair ZX81, mainly because of the price, and learned to program in BASIC on his own.

George's specialty is the "technical and fundamental analysis of stock" from the data provided by some home-brew programs he has developed. The Value Line Investment Survey is his source of information.

Originally the programs were developed on the ZX81, which George fondly describes as "a good number crunching machine". The main program he uses is for "data maintenance", which keeps a year worth of stats on 100 stocks. The results of this program feeds a "graphing" program, so that the data can be viewed and summarized.

When George switched over to the TS2068 a few years ago, it gave the graphing program considerably more detail, and both programs were upgraded to make use of the new machine.



**SILICON MTN. COMPUTERS**  
C-12, Mtn. Stn. Group Box, Nelson BC V1L 2J3

presents... **ZX-TERM\*80**

**THE ULTIMATE COMMUNICATIONS PGM.**  
**FOR THE TS1000, TS1500 & ZX81**

FINALLY... a REAL terminal package for your computer. Would you believe 40, 60, even 80 columns? True windowing? Xmodem up/download? Believe it! ZX-TERM\*80 is here! The price is the clincher: only \$24.95 with comprehensive manual and shipping.

No screen-dump could do justice to this program. This is THE definitive modem terminal program for the ZX81/TS1000 and TS1500.

- Westridge or Byte-Back modems supported.
- Instantly select 40 column, 60-column, or 80-column character widths. You read it right! 80 columns on the ZX81/TS1000! Upper/lower case, and all ASCII symbols, while preserving Sinclair graphics; can even be customized to mimic IBM or other graphics sets.
- Two window modes. "One-window" mode displays all text on a single large screen; "Three-window" mode has separate windows for menus/prompts, your typed output, and received input! Windows 2 and 3 are even adjustable, just like on the "big guys."
- Allows XMODEM up/downloading of ASCII files, Sinclair programs, EVEN SINCLAIR VARIABLES! Usable with word-processors and similar programs.
- TS2040 and "big" printers supported, via any of the popular interfaces.
- Revolutionary modem input routine allows you to adjust windows, change width mode, etc. without losing a single incoming character.
- Relocatable, and usable with 16, 32, or 64K RAM.
- Takes only 4K at the top of memory, plus the 8K SCRAM board (or eq.)
- Review files in either Sinclair or ASCII mode.
- Allows local echo to be enabled or disabled.
- "Beginner-friendly" while maintaining full flexibility for customizing and "hacking."
- Redefined, auto-repeating keyboard works like a true upper/lower-case terminal.



## Professional's use TS computers

For the past eight years, George has worked out of his home. He deals a lot in options, and large NY Exchange stocks, such as (just off the top of his head), American Airlines and Etna Life. Along with the Timex computers, he also owns an IBM clone which he tinkered with for a while, but found the TS computers to be more suitable for his needs.

"I really enjoy programming in BASIC...I think the TS2068 is a fantastic little computer", related George.

He is also willing to correspond with anyone interested in the same field. Write to: 311 Michelle Lane, Daly City, CA 94015.

## Sinclair Dealer

Rod Gowen, proprietor of RMG Enterprises has been a Sinclair computer dealer since 1981. Before that he was in the home electronics, auto sound, and CB radio retail business. The last two years he has been at it full time, working out of the basement of his Oregon City, Oregon, home. The business is primarily mail order, but Rod also has a large amount of equipment set up for demonstration to local walk-in business "by appointment". He has also worked in to the business, generic computer items like printers, monitors, disk drives, floppy disks, cables, ribbon re-inkers, printer stands, and even other lines of computers besides the Sinclair. But the Timex Sinclair business has remained the

mainstay and accounts for most of his business activities. Rod currently stocks over 500 items, with a total inventory value of \$36,000 retail.

Several computer systems help Rod in running the business. The primary system is a Sinclair QL that runs three business software packages programmed by Vince Lyon of Executive Workshop, but highly modified and customized by Rod.

One program is actually a "two in one" package, which does the inventory and invoicing, another program stores the customer files, and there is a general accounting program. All data is stored on double density quad disk drives, and a Miracle System's Trump Card is also used. Hard copy can be obtained from an Okidata 180 printer.

Rod extensively uses RAMdisk-ing with his business software, especially the inventory and invoicing program. One example, is a UPS shipping charge data file that can be called up and automatically calculates UPS charges.

For general correspondence, Rod uses a TS2068 with TASWORD and a Ramex disk drive system (running a Larken DOS cartridge). Printouts are done on either the Okidata or Blue Chip printers.

Another TS2068 system is dedicated to the RMG BBS which is online in the evenings until early morning (call 503-656-8072; setting 8/1/N). It is running CASBOARD software, with an Aerco disk drive system and dual quad 800K drives.

Rod stays very busy with a current customer base of over 1,032. He is also the treasurer of the local Timex Sinclair Users Group. You can write to him at: RMG Enterprises, 1419 1/2 7th St., Oregon City, OR 97045.

LARKEN Introduces ...

## 256K for your TS-2068

\*\*\*\*\* NEW LARKEN RAMDISK \*\*\*\*\* Now you can expand your 2068 to up to 256K of nonvolatile Ram with the New Larken Ramdisk system. The Ramdisk system consists of the Larken LKDOS Ex-Basic cartridge and a rear mounted nonvolatile memory board. The LKDOS operating system uses all the standard Basic commands to operate the Ramdisk such as LOAD SAVE CAT MERGE FORMAT ERASE etc, so its as easy to use as a cassette or Floppy disk.

The Ramdisk memory board uses the new 32K x 8 static ram chips (62256-LP) and comes with 64K of Ram. You can add more chips for up to 256K. Battery Backed up. Very Fast and reliable. Its fully Spectrum and OS-64 and floppy disk compatible (Larken, Ramex or Oliger). Tape backup program included.

-- PRICE : RamDisk with 64K, and LKDOS Ex-basic Cartridge ..... \$129.95

\*\*\*\*\* 400K 2068/Spectrum Floppy disk Interface \*\*\*\*\* The disk interface can support up to 4 - 3" to 5.25" SS DS or Quad (800K) drives. An NMI Snap-shot push button and KEMPSTON joystick port are on the disk Interface. It can load 32K in less than 4 seconds. Add \$8 for cable.

-- PRICE: 400K Disk Interface and LKDOS cartridge ..... \$119.95  
-- Complete System: Ramdisk (64K), 400K Floppy disk IF and LKDOS .... \$179.95

\*\*\*\*\* AERCO RAMEX or OLIGER disk users \*\*\*\*\* You can now have LKDOS for your disk IF for Spectrum, OS-64 and Larken disk compatibility and also RamDisk Capability. An NMI button can be added for Snapshot memory saves. Also use of all LKDOS Ex-basic commands including LOAD,SAVE,CAT,FORMAT,MERGE,ERASE,FILL,WINDOWS, etc. Send for info.

-- PRICE: LKDOS (Aerco Ramex or Oliger) .... \$65  
-- Spectrum Emulator added to any product above .....\$20.00

\*\*\*\*\* LKDOS SOFTWARE \*\*\*\*\* ( all software will run on any Lkdos based floppy disk or ramdisk or combination. Supplied on 48 tpi 5.25" disk, or on cassette .)

-SEQUENTIAL FILE SUPPORT PACKAGE - This ram based Lkdos extension allows sequential files to be Opened, closed, written to or read from using the Basic commands OPEN, CLOSE, PRINT#, INPUT#, INKEYS# etc. ... \$10.00

- XMODEM to LKDOS MODEM PACKAGE - Lets you up or down load 2050 modem files directly to disk with out any buffer size limitations. Transmit or recieve files as large as 100K. Lkdos users can send entire NMI saves over the modem. Mini terminal mode. ... \$10.00

- LKDOS DISK EDITOR - This program lets you modify any block on the disk, map out bad blocks, reformat single tracks and more. Complete documentation on Lkdos operation and accessing the dos from machine code is included. ... \$10

.... ALL PRICES ARE \$US ..... ADD \$5 S&H FOR HARDWARE ..... ADD \$2 S&H FOR SOFTWARE .....

===== LARKEN ELECTRONICS RR#2 NAVAN, ONTARIO, CANADA, K4B-1H9, (613)-835-2680 =====

# Z88...more on Sir Clive's microchip wonder

Tim Woods



The most common question I receive from those who are curious about this new machine, is: "does it have disk drives?" It's obvious, considering that the computer weighs two pounds with batteries installed, that the Z88 does not include a floppy drive mechanism. As far as an external unit, it is extremely possible using the expansion buss provided on the right-hand side...it's only a matter of time before Cambridge or an aftermarket developer can put together a system.

Currently, data can be IMPORTED/EXPORTED to either a Sinclair QL (see more details shortly) or an IBM PC, using the optional "PC LINK" software, and then the data can be stored as a file, using the host computer's own disk storage medium.

But, before one would write the Z88 off as "weak" or "lacking a disk drive facility", the design concept of the computer needs to be seriously examined. This is a truly portable computer. You can tuck it under your arm and run with it. Other computers claiming to be portable or laptop, weigh in excess of 10-12 pounds. They are transportable, but are they really, day after day, a personal portable computer, designed to be a tool you carry with you wherever one might go?

The expansion memory card system on the Z88 was designed as a completely integral part of the machine, and not just an afterthought. The memory cards are the "disk system" of the Z88, and are treated as such. When Sir Clive was first contemplating a portable computer, the Microdrive cartridges were looked at as a possible option for mass storage. He has gone one step further and offered their electronic counterpart...and they are considerably more reliable.

Since our last review of the Z88, I went ahead and sprang for a 128K RAM CARD, which I ordered from Sharp's, Inc. for \$85.00 ppd. The following picture is the actual size of the card (or cartridge). It inserted very snugly in the #1 cartridge slot, and once installed, it is almost there to stay. The 128K card was accompanied by some documentation sheets that provide a crucial information link. The Z88 User Guide contains very little on the subject of the memory cards.

There are three types of cards available (or soon to be) for use with the Z88: 1) RAM cards for storing your own information. 2) ROM cards, which will be available as commercial software, and are not programmable by the user. 3) EPROM cards which can be programmed one time only (unless erased) by the user for permanent data storage.

As we mentioned in the last issue, slot #3 doubles as an EPROM programmer. RAM, ROM, and EPROM cards can be used in all three slots. However, and this was surprising to me, the documentation states that, "it is recommended that you avoid using slot 3 for RAM cards because RAM cards draw more current in slot 3 than they do in slots 1 and 2". This kind of throws a monkey wrench at Cambridge Computer's current ad campaigns in Europe, in which they always quote system RAM expansion X 3. So technically, according to the docs, the user is advised to have RAM cards in only slots one and two. You could run it in three, but it isn't advised. Slot three can be reserved to "burn" EPROMs or for booting up commercial software as it becomes available. I will probably spring for another 128K card sometime soon (I need to start saving my pennies!).

The extra RAM makes a big difference. It takes an already excellent little computer and feeds it tremendous power. No longer does one run out of memory in the "suspended activities" area of the INDEX page. To use the extra RAM is extremely easy, you simply go to the PANEL menu and set the Default Device to: RAM.1 (if the new RAM card resides in slot #1), or if you would like to keep the system default to internal RAM (RAM.0), you could access the additional RAM from within the device selection of the FILER.

Cambridge Computer still insists that the U.S. launch of the Z88 laptop will be late February or early March. A few rumors have come down the pipe, such as, there is a holdup on FCC approval. Another rumor has it that, although the suggested retail price stands at \$499, that a special introductory price will be offered, or an expansion RAM Card (or a modem) will be given away to sweeten the deal.

I have also heard through the grapevine, that there may be a special ROM revision for units shipped to the U.S.

To check which ROM version you have in your own Z88 is easy: from any popdown or application program (other than PIPEDREAM), press the key for the HELP page, then press the Left cursor key once. This will give you the Copyright page, and the top line gives the ROM version.

Incidentally, I have been exchanging notes with Rob Curry, of Curry Computer, who has had his Z88 considerably longer than I have. Rob reported that his ROM version is 1.41, and has detected a few "bugs". The version I have is 2.2, and so far haven't uncovered any of the unwanted pests.

In the November/December '87 issue of TIME DESIGNS, we took our first look at the Z88...the latest computer design from Sir Clive Sinclair. We examined the physical components (keyboard, display, battery requirements) and even took a peek at what's inside the compact case. We also described (briefly) the 12 internal programs that are built in. Also, a small mention was made of the expandability through the cartridge dock and the serial port.

In this installment, we will take another look at the concept of memory cards in the cartridge dock. I will review the first two aftermarket devices released for the Z88, and finally wrap this up with a few observations.



As previously mentioned, the additional RAM works like having a disk drive. You LOAD and SAVE just as you would any program file. In the FILER, it keeps a list of files currently in RAM. You can carry around with you a tremendous amount of data, and its all safely backed-up by batteries!

#### MIRACLE SYSTEMS CENTRONICS INTERFACE

Well, it's going to be all uphill from here on. Aftermarket development has begun, and the first products are starting to emerge for the Z88. The Miracle Systems Centronics Printer Interface is the first of such items that I have tested. And if this is any indication of what's ahead, it's going to be an enjoyable experience. This new printer interface works just about as flawless as anyone could hope for...you basically plug it in and start printing.

To back things up just a bit, the Z88 comes with an RS-232 Serial port. Unless you have a printer that is serial compatible, your kind of stuck. In our office, our QL printer is serial...but beware, if you try as I did to use the cable supplied with the QL printer (Sekosha 800), it won't work. The serial ports on the QL and Z88 are incompatible with each other (one data line is wrong).

The Miracle Systems interface does the trick. Since the printer I use most often with other computers requires a parallel input, this was my ticket to happy printing with the Z88. It converts the serial information into parallel data, with only a slight bit of a delay (very un-noticeable). If you have an Epson compatible printer, no changes to the PRINTERED program will need to be made. Printing can take place from BASIC, PIPEDREAM, and the DIARY.

The circuit of this interface is contained in the portion that plugs into the printer, with an extra long cable attached. At the other end is the small serial connection for the Z88.

This product works as well as could be hoped for. My recommendation should be obvious...if this is what you need to get printing, buy it! I obtained mine from Curry Computer. Write for current pricing.

#### Z88 TO SINCLAIR QL LINK

This combination software package (Microdrive cartridge) and cable, that hooks the Z88 serial port up to the Serial I port on the QL, was developed by Sector Software in Great Britain, and is being marketed over here by Sharp's Inc. The price is \$39.95.

The software portion of this package is called "QZ FILE TRANSFER", and the title sums up what it's sole function is...it enables the Z88 user to dump a file and store it on either a Microdrive cartridge, or if the users system can accommodate, on floppy disk. The documentation for this software package is supplied as a QUILL document. The software is version 1, and the author of the program is looking for additional ideas for upgrades (which registered owners will receive free of charge).

Unfortunately, the Sinclair QL I normally use, was malfunctioning at the time I wanted to test this software package. Knowing the quality of other Sector products, I can probably guess that I am in for a treat. But I will report on my findings next issue...that is, if I get the QL repaired.

Well, that about wraps it up for this issue. Next time I will be experimenting with the built in telecommunications software and a modem, using a cable I have on order from Curry Computer. I will also dabble in a bit of BBC BASIC. Actually, in looking over the list of commands...this is quite a powerful implementation of the BASIC language.

I might add, that after a number of months of steady use, and many sets of batteries, I have grown quite fond of this little computer. Since I am "on the go" all day long, it really suits my lifestyle. The wordprocessor, diary, calculator, database and spreadsheet are very useful tools that I use day in and day out. I might go as far as to say that it is the best computer I have owned for those particular reasons.

I know that many of you are holding back judgement on this newest member of the Sinclair family, for the fact that you have seen too many good little computers orphaned in the last few years. We can only hope that Cambridge and Sir Clive

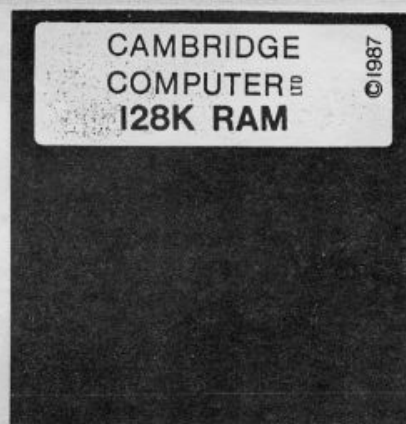
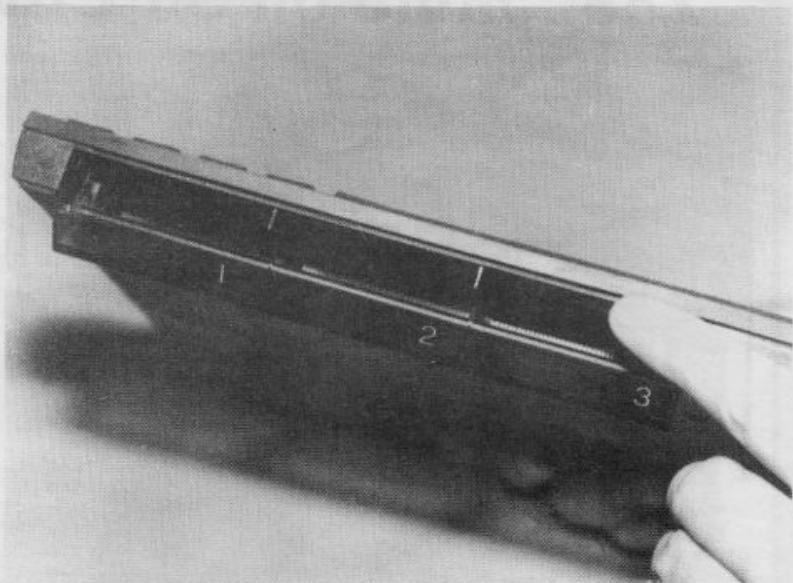

can at last successfully market a good product without the bumbblings and failures that have taken course in previous attempts. It's a tough market now and just having a good product is not enough.

I am working on getting enough interest to form a national user group and newsletter for the Z88. If you would like details on this (you don't have to own a Z88), send a S.A.S.E. to: Tim Woods, c/o TDM, 29722 Hult Rd., Colton, OR 97017.

# 1987 Federal Income Tax Calculator

Herb Bowers, Sr.

NOTE: The following program can be typed in, without any modification, on your ZX81/TS1000/TS1500 and TS2068/Spectrum.

IT'S THAT TIME AGAIN FOLKS! And with the following program, you will be ready for it. Yup! It's that festive season of the year lovingly referred to as the good old "TAX SEASON".

As you may have guessed, the phrase "TAX SIMPLIFICATION" is an oxymoron. It is about the same as Jumbo Shrimp and the U.S. Postal Service. In fact, just figuring the proper standard deduction is a job in itself, and I am sure that many individual taxpayers will end up cheating THEMSELVES in this respect.

For instance, there is no longer any additional exemptions for age 65 or over, or for people who are blind. Instead Uncle has built an additional STANDARD deduction into the law. Notice that I emphasized the word STANDARD. If you itemize your return, there is NO additional allowance or deduction.

Let's take a couple, both age 66, who are using filing status 2, MARRIED FILING A JOINT RETURN. First of all, they will get 2 exemptions, (not 4 as in the past), for a total of \$3,800. The standard deduction, \$3,760, is increased by \$2,440 which gives them a total STANDARD deduction of \$6,200. However, they have a lot of medical expenses, Real Estate Taxes, some Interest Expenses and deductible contributions, which came to a total of \$7,000. This is \$800 greater than the STANDARD deductions, so they intend to ITEMIZE. Lets give them \$20,000 taxable retirement income.

OK. We take the \$20,000 income and deduct from it the \$3,800 exemption and the \$7,000 worth of itemized deductions which leaves them with taxable income of \$9,200. Notice that there is nothing extra allowed for their ages. The \$2,440 has totally disappeared. Had the couple each been 21 and the \$20,000 been earned income, the taxable income still would have been \$9,200. The older couple was penalized by losing the additional \$2,440 deduction they would have been allowed had they used the STANDARD deduction. For the younger couple there was not any penalty. This means that the old folks \$7,000 was worth only \$4,560. You did it to us again Ronny.

I swore I wasn't going to get on a soap box again this year, but there I go again. Lets get down to business.

I have written this program using no multi-statement lines or DATA statements. Originally I had written two programs. One of the programs had multi-statement lines and DATA statements, and the other did not. In an effort to save space in TDM and to avoid confusion, I decided to eliminate everything that would not be compatible with you computer regardless of the model. Only CAPS mode was used. I also found that by putting the DATA in D\$, I saved a lot o bytes.

I think that you can type this program in and use it without any further documentation or further explanation.

If your computer has caps and lower case modes, use the CAPS mode when running it. On the TS2068 and the Spectrum you can add a line at 105 POKE 23658,8 to accomplish this. If your computer has a FAST mode, add line 475 FAST and line 485 SLOW..but that is optional. If you have lower case capability, use it "ad lib" when entering text.

Pay particular attention to line 440 and be certain you are using the correct operators. You can eliminate the REMS if you feel so inclined and eliminate all the extraneous spaces. The PRINT position notation was not used because this is not standard notation on some of your computers. Just use the appropriate number of commas to obtain the correct PRINT positions.

The program will calculate the proper standard deduction for you. In the event you are taking itemized deductions, the program will select the higher of standard or itemized deduction and deduct that figure only. This feature alone is worth the effort of typing in this program.

Another unique feature of the program is the calculation of the tax on NET CAPITAL GAINS, which during this transition year (1987) is limited to 28% maximum on these gains. In 1988 the maximum tax rate will be 28% and no adjustment will be required. I must note here that I am writing this the week of October 19th...the week the New York Stock Exchange went bananas, so for 1987 the expression CAPITAL GAIN may also become an oxymoron.

The program has not been written with any ERROR TRAPPING, so be careful when you RUN it. I have some really nifty error trapping routines and if Tim will allow me, I will publish a few of 'em right here in the pages of TDM sometime soon.

You have my blessing to incorporate this program, as written, into any of your own tax programming endeavors. As far as I am concerned, it is public domain as of this minute. (It would be nice if you gave the old man here, or my company ABBA SOFT a little credit.)

You will not be able to use this program if you can be taken as a dependent on another persons return. Special rules apply. Also for children under age 14 who have investment income greater than \$1000, Form 8615 must be used.

Final Note: I have released a complete 1040 tax program which is called QWIK-1040, that will quickly prepare your entire 1987 Federal Tax Return including schedules.

If you have any questions, you can drop me a line. If you don't have any questions, you can drop me a line also. It's lonely out here in the sticks! Herb Bowers, Sr., 2588 Woodshire Circle, Chesapeake, VA 23323.

```
0>REM 1987
**FEDERAL TAX CALCULATOR**
BY: HERB BOWERS, SR.
NOVEMBER 1987
FOR: ZX-81, T/S 1000, T/S 1500,
T/S 2068, SINCLAIR SPECTRUM
PC8300, TK90X AND TK 95
*****
100 REM INFORMATION INPUT
110 PRINT AT 8,0;"ENTER FILING
STATUS:";TAB 4;"1. SINGLE";TAB 4
;"2. MARRIED FILING JOINT";TAB 4
;"3. MARRIED FILING SEPERATE";TA
B 4;"4. HEAD OF HOUSEHOLD";TAB 4
;"5. QUALIFYING WIDOW/ER"
120 INPUT F$
130 CLS
140 PRINT AT 9,0;"HOW MANY DEPE
NDENTS BESIDES YOU";" AND YOUR S
POUSE" AND F$=2;"?";TAB 4;"IF NO
NE THEN ENTER 0"
150 INPUT EX
160 LET EX=EX+1+(F$=2)
165 LET AA=0
170 FOR F=0 TO F$=2
180 CLS
190 PRINT AT 9,0;"ARE YOU" AND
NOT F;"IS SPOUSE" AND F;" 65 OR
OLDER";TAB 12;"Y OR N"
200 INPUT I$
210 LET AA=AA+(I$(1)="Y")
220 CLS
230 PRINT AT 9,0;"ARE YOU" AND
NOT F;"IS SPOUSE" AND F;" BLIND?
";TAB 12;"Y OR N"
240 INPUT I$
250 LET AA=AA+(I$(1)="Y")
255 NEXT F
270 CLS
280 PRINT AT 9,0;"ENTER ADJUSTE
D GROSS INCOME","FORM 1040,LINE
31; 1040A,LINE 13","1040EZ, LINE
3"
```



```

290 INPUT AG
300 CLS
310 PRINT AT 9,0;"ENTER NET LONG TERM CAPITAL GAIN(SMALLER OF LINE 17 OR 18, SCH.D) (IF 0 OR LESS THEN ENTER 0)"
320 INPUT CG
400 CLS
410 PRINT AT 9,0;"ENTER TOTAL ITEMIZED DEDUCTIONS", "LINE 26, SCHEDULE A", "(IF NONE THEN ENTER 0)"
420 INPUT ID
430 CLS
435 REM ■STANDARD DEDUCTION CALCULATION
440 IF AA THEN LET AA=((F5=1)*((AA=1)*1210)+(AA=2)*1960)+((F5=2 OR F5=5)*((AA=1)*1640)+((AA=2)*2440))+((F5=3)*((AA=1)*1220)+(AA=2)*1820))+((F5=4)*((AA=1)*2610)+(AA=2)*3360)+(AA=2)*500)+(AA=3)*600)
450 LET SD=(2540*(F5=1 OR F5=4))+3760*(F5=2 OR F5=5)+(1880*(F5=3))+AA
460 LET TA=AG-((SD>ID)*SD)-(ID>SD)*ID-EX*1900
465 REM ■PRINT INFO TO SCREEN
470 PRINT "■FEDERAL INCOME TAX CALCULATION■", "■FILING STATUS■=", F5, "■EXEMPTIONS■=", EX, "■ADJUSTED GROSS INCOME■=", AG, "■LESS: ■EXEMPTION■", "■S■ AND ■EX>1■", "■1900■", "■EX*1900■", "■LESS: ■ITEMIZED DED.■", "■ID AND ID>SD■", "■LESS: ■STANDARD DED.■", "■SD AND SD>ID■", "■TAXABLE INCOME■=", TA*(TA>0), "■NET CAPITAL GAIN■=", CG, "■TAX LIABILITY■=",
480 GO SUB 1000
490 PRINT TAX, "BEFORE CREDITS OR ADD'L TAXES"
500 PRINT "ENTER TOTAL FEDERAL WITHHOLDING"
510 INPUT WH
520 LET L=WH-TAX
530 PRINT AT 19,0;"TOTAL FEDERAL WITHHELD=", WH, "YOUR REFUND IS:", "AND L">0;"YOU OWE:", "AND L"<0;"$";ABS L
540 STOP
1000 REM ■TAX CALCULATION CONTROL
INPUT: TA=TAXABLE AMOUNT
CG=NET CAPITAL GAIN
F5=FILING STATUS (1 TO 5)
OUTPUT: TAX=TAX LIABILITY
1010 IF TA>=25 THEN GO TO 1040
1020 LET TAX=(TA>=5)+(TA>=15)
1030 RETURN
1035 REM ■SEPARATE CAPITAL GAIN
1040 LET MX=(27000*(F5=1))+ (45000*(F5=2 OR F5=5))+ (22500*(F5=3))+ (36000*(F5=4))
1050 LET CGT=(CG+.28)*(TA>MX)
1060 LET CGA=CG*(CGT>0)
1070 LET L=(TA-CGA)/100
1080 IF NOT CGA AND TA<50000 THEN GO TO 1140
1090 REM ■X, Y, Z, SCHEDULES
1100 GO SUB 1300
1110 LET TAX=INT ((L+CGT)+.5)
1120 RETURN
1130 REM ■TAX TABLE AMOUNTS SET UP BRACKETS
1140 LET BR=25+((L>30)*25)
1150 LET B1=INT (TA/BR)
1160 LET B2=B1*BR
1170 LET B3=B2+BR
1180 LET L=B2/100
1185 REM ■BEGIN CALCULATION
1190 GO SUB 1300
1200 LET L1=L
1210 LET L=B3/100
1220 GO SUB 1300
1230 LET L2=L
1240 LET TAX=INT ((L1+L2)/2+.5)
1245 REM ■END CALCULATION
1250 RETURN
1300 REM ■DATA CONVERTER
1310 LET LO=0
1320 GO SUB 1500
1330 FOR F=1 TO 60 STEP 12
1340 LET HI=VAL D$(F TO F+2)
1350 LET PLUS=VAL D$(F+3 TO F+7)
1360 LET PCT=VAL D$(F+8 TO F+11)
1370 IF L>LO AND L<=HI THEN GO TO 1400
1380 LET LO=HI
1390 NEXT F
1395 REM ■UPPER/LOWER PARAMETER BRACKET TAX
1400 LET L=(L-LO)*PCT+PLUS
1410 RETURN
1500 REM ■PSEUDO-DATA
1510 REM ■SINGLE
1515 IF F5=1 THEN LET D$="0180000000111680019800152700244800285400530400359E91475438.5"
1520 REM ■JOINT;0/W
1525 IF F5=2 OR F5=5 THEN LET D$="03000000000112800033000154500408000289000884000359E92459038.5"
1530 REM ■MARRIED FILING SEP.
1535 IF F5=3 THEN LET D$="0150000000111400016500152250204000284500442000359E91229538.5"
1540 REM ■HEAD OF HOUSEHOLD
1545 IF F5=4 THEN LET D$="0250000000112300027500153800335000288000755000359E92225038.5"
1550 RETURN

```

\*\*\*\*\*  
**P U Z Z L E O F T H E M O N T H**  
\*\*\*\*\*

The following TANTALIZER by Martin Hollis appeared in a 1974 issue of the New Scientist, a British research journal.

Tantalos of Thrace bowed low before King Xerxes and declared, "I bring your Majesty some goats, more sheep and yet more oxen, may it please your Majesty."

"How many of each?" inquired the king.

"3150, Sire,...."

"That is satisfactory."

"...If multiplied together, Sire."

"That is not satisfactory. How many of each, dolt?"

"As many in total, when added together, as the number of your Majesty's wives, Sire."

"I cannot deduce the exact number of each from that, O base Greek. How many of the beasts are oxen?"

"Less than half the total, Sire."

"Now I can deduce the number of each and it is not satisfactory!"

Write a program for our computers to solve this riddle. How many each of goats, sheep and oxen did Tantalos bring to the king???

CEDRIC R. BASTIAANS

# Quadra - Chart +

Bill Ferrebee

I continue my on-going series of software enhancements with a very simple but useful addition to Timex's answer to "presentation graphics"...QUADRA CHART.

QUADRA CHART is a TS2068 program that was marketed by Timex themselves, and should still be available at a very reasonable price from many of the TS dealers around the country.

QUADRA CHART enables you to convert numerical data (such as Sales Figures, or Inventory Totals) into four types of graphs:

1. Bar
2. Pie
3. Line Pie
4. Line

Any one, or all four of the graphs may be displayed on the screen at once. The Screen can also be printed on a TS2040 thermal printer.

The modification we will make, will enable the screens to be saved to tape (or disk), so that they can be enhanced with any of the fine TS graphics programs available. This means text can be added, pie sections can be "filled"...and most importantly, the finished graph can be printed on a full size dot matrix printer.

The examples accompanying this article give you just a few examples of what can be done. The procedure for installing our QUADRA CHART + routine is as follows:

1. Load the program loader and first screen with LOAD "".
2. Once the cover screen finishes loading, STOP THE TAPE and BREAK.
3. Insert a fresh tape in your recorder and enter GOTO 110.
4. Once the loader and screen are saved, STOP THE TAPE.
5. Reset the computer, place the original tape in the recorder and enter MERGE "":LOAD "" CODE: LOAD "" CODE.
6. Once the condition code appears in the lower left corner, add or modify the following lines:
  - a: add to
  - m: modify
  - n: new line

```
a 112 ;AT 21,10;"s=save screen"
n 119 IF INKEY#="s" THEN GOSUB 8700
m 2360 INPUT AT VAL "0", VAL "0";"r=restart,w=window,c=copy,
s=save";j$
n 2396 IF j$="s" THEN GOSUB 8700
m 6520 INPUT AT VAL "0", VAL "0";"r=restart,w=window,c=copy,
s=save";j$
n 6566 IF j$="s" THEN GOSUB 8700
m 7320 INPUT AT VAL "0", VAL "0";"r=restart,w=window,c=copy,
s=save";h$
n 7366 IF h$="s" THEN GOSUB 8700
a 7932 ;AT VAL "21", VAL "10";"a=save screen"
n 7941 IF INKEY#="s" THEN GOSUB 8700
n 8700 INPUT "Name?:";q$
n 8710 SAVE q$ SCREEN$: RETURN
```

Sample Chart

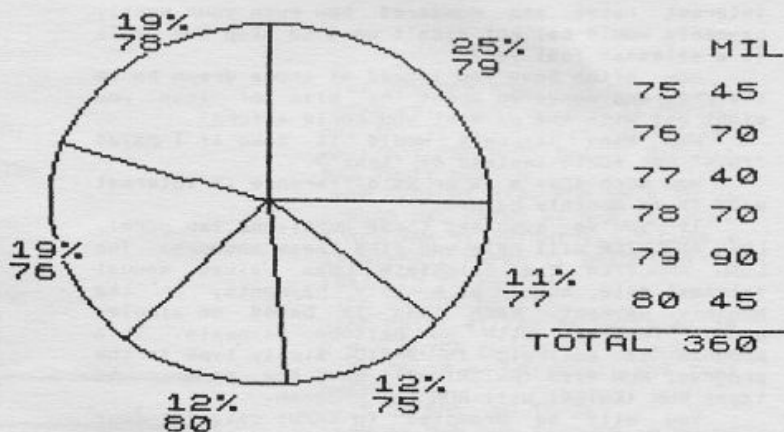

Modified Sample Chart

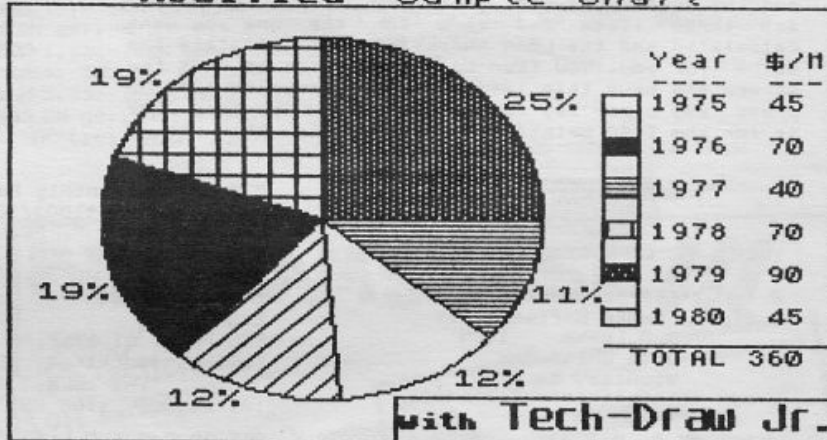

7. Once you have entered the lines, place your backup tape into the recorder and enter GOTO 9990. This will save the modified program and accompanying screens.

I hope that this added feature enables you to produce professional looking graphics with your TS2068 computer.

## SOLUTION OF THE PUZZLE OF THE MONTH

NOTE: In line 60 I first tried to key in IF O>S>G AND... but this wasn't accepted. In about 13 seconds, the 2068 will print: 6 goats, 21 sheep, and 25 oxen (52 wives); the only solution given by Hollis. A little over a minute later, it will also come up with: 10 goats, 15 sheep and 21 oxen (46 wives).

```
70 NEXT 0
80 NEXT 8
90 NEXT 6
100 STOP
```

To solve the TANTALIZER riddle, I made many assumptions, such as there would probably not be less than 6 goats and not more than 15. The latter simply based on taking the cubic root of 3150 = 14.659. There would then be progressively more of sheep and oxen, say respectively 10 to 25 and 20 to 50. These assumptions proved to be totally acceptable and the TS2068 even gave TWO solutions, whereas Martin Hollis gave only one, but that was before the TS2068 was invented of course!

Key in the following program:

```
10 FOR G=6 TO 15: REM GOATS
20 FOR S=10 TO 25: REM SHEEP
30 FOR O=20 TO 50: REM OXEN
40 REM WIVES: LET W=G+S+O
50 REM PRODUCT: LET P=G*S*O
60 IF O>S AND S>G AND O<(W/2) AND P=3150 THEN PRINT G;" GOATS";S;" SHEEP";O;" OXEN"
```



# Loan Analyzer

Stan Lemke

How often have you looked at those new car interest rates and wondered how much your monthly payments would be, but didn't want to stop and talk to a salesman just yet?

How often have you looked at those dream house sketches and wondered about the size of loan you might get with the payment you could afford?

How many payments would it take if I payed "this" per month instead of "that"?

How much does a 1% or 2% difference in interest make in my monthly payment?

If you've ever had these questions (an more), LOAN ANALYZER will help you find these answers. The LOAN ANALYZER can calculate Loan Values, annual interest rate, number of monthly payments, or the monthly payment. Each loan is based on simple, annual interest with no balloon payments. This program is entirely in BASIC. Simply type in the program; RUN 9999 (ENTER) will SAVE the program to tape; RUN (ENTER) will RUN the program.

You will be prompted to INPUT data for four loan variables: Loan Amount, Interest Rate (annual interest rate in %), the Number of Monthly Payments, and the Monthly Payment. Actually, input data for any three items and zero for the one you want calculated and the LOAN ANALYZER will calculate the value for you. You then have the option to COPY the screen and save this information by pressing "C", or press any other key for a new loan. NOTE: this COPY is for the 2040 printer, you can route this to a

Loan Terms	
\$2000	Loan Amount
18	% Annual Interest
24	Number of Payments
\$99.85	Monthly Payment

full size printer by LOADING your customized printer driver code, and substitute the appropriate RANDOMIZE USR command in line 3000.

Let's look at an example: What is the monthly payment for a \$2000 loan at 18% annual interest and 2 year term? INPUT the following: 2000 (ENTER) for Loan Amount, 18 (ENTER) for Annual Interest Rate, 24 (ENTER) for a 2 year term (2 times 12). In this case the LOAN ANALYZER will not wait for you to input the last variable as zero, but immediately calculates a monthly payment of \$99.85. You can now press "C" to COPY, or any other key to continue. Try INPUTting zero for the Loan Amount, Annual Interest Rate, and Number of Payments...and LOAN ANALYZER will quickly calculate these for you.



```
1 REM      LOAN ANALYZER
2 REM *****
3 REM by Lemke Software Dev
  S D Lemke 1984
  2144 White Oak
  Wichita, Ks 67207
4 REM *****
```

```
20 BRIGHT 0: PAPER 1: BORDER 1
: INK 7: CLS : PLOT 30,155: DRAW
200,0: DRAW 0,-80: DRAW -200,0:
DRAW 0,80: PLOT 28,157: DRAW 20
4,0: DRAW 0,-84: DRAW -204,0: DR
AW 0,84: PRINT AT 3,5;"Loan Term
s"
```

```
30 PRINT AT 5,4;"$----- L
oan Amount";AT 7,4;"--- % Annu
al Interest";AT 9,4;"----- Numbe
r of Payments";AT 11,4;"$----
Monthly Payment"
```

```
35 PRINT AT 17,1;" Input Data
for any 3 Items.";AT 19,1;" Pre
ss "ENTER" when done.";AT 20,1
;" Input 0 to Skip an Item."
```

```
40 LET L=0: LET I=0: LET N=0:
LET P=0: FOR c=1 TO 4
```

```
50 IF c=1 THEN PRINT AT 5,5;
FLASH 1; OVER 1;" "
```

```
60 IF c=2 THEN PRINT AT 7,4;
FLASH 1; OVER 1;" "
```

```
70 IF c=3 THEN PRINT AT 9,4;
FLASH 1; OVER 1;" "
```

```
80 IF c=4 THEN PRINT AT 11,5;
FLASH 1; OVER 1;" "
```

```
90 GO TO (190+10*c)
```

```
200 INPUT "Loan Amount: ";L: LE
T L=INT (L*100)/100: LET loan=L:
PRINT AT 5,5;" ": PRINT
AT 5,5;L: GO TO 240
```

```
210 INPUT "Interest Rate: ";i:
LET i=INT (i*100)/100: LET ir=i:
PRINT AT 7,4;" ": PRINT AT
7,4;i: GO TO 240
```

```
220 INPUT "Number of Payments:
";n: LET n=INT (n): PRINT AT 9,4
;" ": PRINT AT 9,4;n: GO TO
240
```

```
230 INPUT "Monthly Payment: ";p
: LET p=INT (p*100)/100: PRINT A
T 11,5;" ": PRINT AT 11,5;
P
```

```
240 IF L<>0 AND I<>0 AND n<>0 I
HEN GO TO 250
245 NEXT c
```

```
250 PRINT AT 17,2;" ";
FLASH 1;"Working"; FLASH 0;" ";
";AT 19,2;" ";TAB 29;"
";AT 20,2;" ";TAB 29;" "
```

```
255 IF p=0 AND L<>0 AND i<>0 AN
D n<>0 THEN GO TO 280
```

```
260 IF L=0 AND p<>0 AND i<>0 AN
D n<>0 THEN GO TO 1000
```

```
270 IF I=0 AND L<>0 AND p<>0 AN
D n<>0 THEN GO TO 2000
```

```
275 IF n=0 AND L<>0 AND p<>0 AN
D i<>0 THEN GO TO 500
```

```
277 GO TO 30
280 REM
```

Calc Payment

```
285 LET i=i/1200
290 LET p=INT ((L*I)/(1-(1+i)↑
(-n))+0.005)*100/100
```

```
300 LET p=INT (p*100)/100
```

```
310 PRINT AT 11,5;" ": LET
I P$=STR$ P: PRINT AT 11,5; OVER
1;P$
```

```
320 GO TO 3000
500 REM
```

Calc No. of Payments

```
510 LET i=i/1200: LET n=100: LE
T dn=128
```

```
520 LET P1=INT ((L*I)/(1-(1+I)
↑(-N))+0.005)*100/100
```

```
525 IF n>1000 THEN PRINT AT 9,
4; FLASH 1;" Payment is too sma
ll! ": BEEP .1,1: PAUSE 120: LET
i=ir: LET c=4: PRINT AT 17,12;"
": LET n=0: GO SUB 8000:
```

```
GO TO 50
```

```
530 IF p1>p THEN LET n=n+dn: G
O TO 520
```

```
540 LET n=n-dn: LET dn=dn/4: LE
T I n=n+dn: IF dn>=0.5 THEN GO TO
520
```

```
550 LET n=INT (n+.8): IF n<=480
```

```
THEN PRINT AT 9,4;" ": PRI
NT AT 9,4;n: GO TO 3000
```

```
560 PRINT AT 9,4; FLASH 1;" Pay
ment is too small! ": BEEP .1,1
```

```
: PAUSE 120: LET i=ir: LET c=4:
PRINT AT 17,12;" ": LET n=0:
```

```
GO SUB 8000: GO TO 50
1000 REM
```

Calc Loan

```
1010 LET i=i/1200
1020 LET L=p*(1-(1+i)↑(-n))/i
```

```
1030 LET L=INT (L*100)/100
```

```
1040 PRINT AT 5,5;" ": L
ET L$=STR$ L: PRINT AT 5,5; OVER
1;L$
```

```
1050 GO TO 3000
2000 REM
```

Calc Interest

```
2010 LET i=0.010
2020 FOR J=1 TO 80
```

```
2030 LET I2=p*(1-(1+i)↑(-n))/L
```

```
2040 LET i=(1+I2)/2
```

```
2050 NEXT J
```

```
2060 LET i=INT (i*120000)/100
```

```
2070 LET I$=STR$ I: PRINT AT 7,4
;" ": PRINT AT 7,4; OVER 1;I
$
```

```
2075 LET i=i/1200
2077 IF p<(L/n) THEN PRINT AT 9
,4; FLASH 1;" Payment is too sma
ll! ": BEEP .1,1: PAUSE 120: LE
T i=ir: LET c=4: PRINT AT 17,12;
" ": LET i=0: GO SUB 8000:
```

```
GO TO 50
```

```
2080 GO TO 3000
```

```
3000 PRINT AT 17,0;"Press "C"
to COPY, any other key to contin
ue.": PAUSE 0: LET is=INKEYS: IF
is="C" OR is="c" THEN COPY : G
O TO 3000
```

```
3010 GO TO 20
```

```
8000 PLOT 30,155: DRAW 200,0: DR
AW 0,-80: DRAW -200,0: DRAW 0,80
: PLOT 28,157: DRAW 204,0: DRAW
0,-84: DRAW -204,0: DRAW 0,84: P
RINT AT 3,5;"Loan Terms"
```

```
8005 PRINT AT 5,4;"$";loan;TAB 1
6;"Loan Amount";AT 7,4;ir;TAB 10
```

```
;"% Annual Interest";AT 9,4;n;TA
B 10;"Number of Payments";AT 11,
4;"$";p;TAB 13;"Monthly Payment"
```

```
: RETURN
```

```
9999 SAVE "Interest" LINE 5
```



# TIME ZONES

WILLIAM C. ANDREWS

This program determines time differences is global location, BASE to DESTINATION. These are listed in lines 530 - 540. The difference in CHR# 1 and 2 were taken from the Telephone Directory. More may be added if desired. Time is entered in Greenwich Mean Time. ENTER will advance time 1 minute. BREAK will return to menu.

```

10 GO SUB 5000
20 LET nc=1: REM NUMBER C
COLOR
30 LET tc=2: REM TITLE COLD
R
40 LET np=1: REM No. POSITI
ON
50 LET tl=0: REM WHOLE MENU
   tl=1 means TITLE
ONLY
60 LET l=1: LET D=0
70 BORDER 6: INK 0: PAPER 7: C
LS
  
```

```

B0 LET q#="BASE"
90 LET O#="_____
"
100 LET r#="_____
"
110 GO SUB 290: PAPER tc: BRIGH
T 1: PRINT AT 1,(31-(LEN q#+2))/
2;"#";O#( TO LEN q#);"#
120 PRINT AT 1+1,(31-(LEN q#+2)
)/2;"#";INK 9;q#;INK 0;"#
130 PRINT AT 1+2,(31-(LEN q#+2)
)/2;"#";r#( TO LEN q#);"#": PAPE
R 7: BRIGHT 0: IF tl=1 THEN RET
URN
  
```

```

140 RESTORE 530: FOR N=1 TO 13:
READ z#: PRINT AT 5+N,1: PAPER
nc: INK 9: BRIGHT 1;" ";CHR# (64
+N);"-": PAPER 7: BRIGHT 0;" ";z
#(3 TO ): NEXT N
150 RESTORE 540: FOR N=14 TO 26
: READ B#: PRINT AT N-8,16: PAPE
R nc: INK 9: BRIGHT 1;" ";CHR# (
64+N);"-": PAPER 7: BRIGHT 0;" "
;B#(3 TO ): NEXT N
155 ON ERR RESET
160 PRINT #1;TAB 9: PAPER 6: IN
K 0;" ENTER CHOICE ": GO SUB 290
170 PAUSE 0: LET tl=1: LET Z#=1
NKEY#
175 ON ERR GO TO 20
180 IF D=0 AND Z#<CHR# 65 OR D=
0 AND Z#>CHR# 90 THEN GO TO 20
190 IF D=1 AND Z#<CHR# 65 OR D=
1 AND Z#>CHR# 90 THEN GO TO 580
200 CLS
210 IF Z#="S" THEN GO TO 300
220 LET X=0
230 FOR n=65 TO 90
240 LET X=X+1
250 IF D=0 AND CHR# n=Z# THEN
GO TO 430
  
```

READY NOW! FROM A#B#B#A SOFT

## Don't File Your 1987 Tax Return UNTIL YOU HAVE QWIK-1040

INCLUDES: Form 1040, 1040A & EZ, Sch. A, B & R \* Forms 2106, 2441 Automatic Calculation Income Tax Liability, Child Care Credit Tax-able Social Security, Earned In-come Credit \* Multiple W-2 & 1099 Entry \* 2040 Compatible \* More

\* Easy Manual Transfer to all Official Internal Revenue Forms \*

**Only \$29.50** Postpaid  
-1st Class Mail-  
For Timex/Sinclair 2068 Computer  
QWIK-1040 will calculate allow-  
able IRA's Interest & deductions.  
This program was designed with the taxpayer in mind. It is easy  
for you to accurately prepare your own income tax return **EVEN IF  
YOU HAVE NEVER DONE IT BEFORE!** It is also sophisticated enough  
to be used to prepare returns for others, with or without experi-  
ence. An ideal teaching tool for tax and accounting students.  
**START YOUR OWN TAX PREPARATION BUSINESS. Details included!**

**IF YOU ARE ORDERING LATE:** Ask me for a FREE Automatic Extension  
Form that will give you an additional 4-months to file your 1040  
**GUARANTEE:** IF you must pay any fine  
or penalty as a DIRECT RESULT of using "QWIK-1040", I will pay  
such fine or penalty for you. **Herb Bowers, Sr.**

Schedules "C", "D", "E", "SE", &  
Forms 2119, 2210, 3903, 4137, 4255,  
4562, 4972, 8582, 8598, 8615 avail-  
able in February and March.  
**CHECK OR MONEY ORDER, (US Funds)**

HERB BOWERS, Sr.  
2588 Woodshire Circle  
Chesapeake, VA 23323  
Phone: 804 487-5924

# BINGHAM'S BEST !!!

COLLECTION  
ON CASSETTE  
**\$9.95** ppd

ANOTHER LOOK AT 2068 GRAPHICS

MORE OR LESS by Paul Bingham

\*\*\*\*\*  
2068 GAZER'S GUIDE  
\*\*\*\*\*

Ultra-Easy Designer Graphics  
by Paul Bingham

Ultra-Easy Designer Graphics  
of

2068 WINDOWS  
by Paul Bingham

INCLUDES:  
CLASSY FRONT END  
BY PAUL BINGHAM

SEND TO:  
PAUL BINGHAM  
PO BOX 2034  
MESA, AZ 85214



TIME ZONES

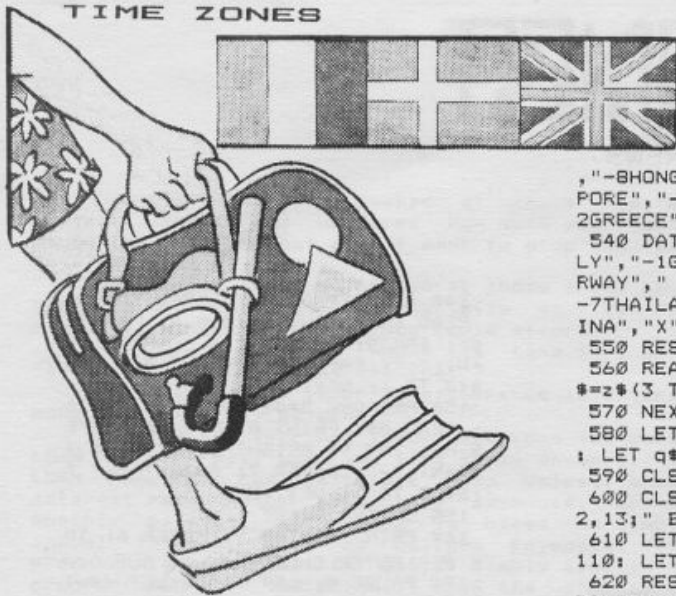

```

260 IF D=1 AND CHR# n=Z# THEN
GO TO 480
270 NEXT n
280 CLS : GO TO 20
290 PLOT 0,0: DRAW 0,175: DRAW
255,0: DRAW 0,-175: DRAW -255,0:
RETURN
300 ON ERR RESET : BORDER 6: PA
PER 6: CLS : PRINT AT 5,12: PAPE
R 1: INK 9: BRIGHT 1: "SAVE? ";A
T 10,7: PAPER 2: "1 "; PAPER 6:
BRIGHT 0: "ON MICROWAFER ";AT 12
,13: "OR ";AT 14,7: PAPER 2: BRI
GHT 1: "2 "; PAPER 6: BRIGHT 0: "
TAPE CASSETTE ": PAUSE 0
310 LET B# = INKEY#: IF B# = "2" TH
EN GO TO 340
320 BORDER 1: PAPER 1: CLS : PR
INT AT 10,10: PAPER 2: INK 9: FL
ASH 1: "RECORDING "
330 SAVE "02,TIME" LINE 20: GO
TO 20
340 ON ERR GO TO 390: BORDER 0
: PAPER 0: CLS : PRINT AT 11,10:
PAPER 2: INK 9: FLASH 1: "RECOR
DING "
350 SAVE "TIME" LINE 20
360 BORDER 1: PAPER 1: CLS : PR
INT INK 7: AT 9,2: "REWIND TAPE--
PRESS ANY KEY TO""TAB 5: "VERIF
Y OR BREAK TO STOP"
370 PAUSE 0: CLS : PRINT AT 11,
10: INK 6: FLASH 1: "VERIFYING "
380 INK 1: VERIFY "": PRINT AT
11,6: PAPER 2: INK 9: "RECORDING
IS O.K. ": BEEP .5,10: PAUSE 20
0: INK 0: GO TO 20
390 FOR n=1 TO 10: BEEP .1,-20-
n: BORDER 1: PAPER 1: CLS : PRIN
T PAPER 1: INK 7: FLASH 1: AT 11
,10: "TAPE ERROR "
400 BORDER 2: PAPER 2: CLS : PR
INT PAPER 2: INK 7: FLASH 1: AT
11,10: "TAPE ERROR ": NEXT n
410 PAUSE 200
420 ON ERR RESET : GO TO 20
430 RESTORE : FOR a=1 TO 26
440 READ B#
450 IF a=X THEN LET I=VAL B#(
TO 2)
460 IF a=X THEN LET s# = B#(3 TO
): GO TO 580
470 NEXT a
480 RESTORE : FOR n=1 TO 26
490 READ D#
500 IF n=X THEN LET J=VAL D#(
TO 2)
510 IF n=X THEN LET f# = D#(3 TO
): GO TO 600
520 NEXT n
530 DATA "08SAN FRANCISCO", "06C
HICAGO", "05NEW YORK", "07DENVER",
"10HAWAII", "-BLONDON", "-1FRANCE"

```

```

,"-8HONGKONG", "-9JAPAN", "-8SINGA
PORE", "-9AUSTRALIA", "-1SPAIN", "-
2GREECE"
540 DATA "06NEW ORLEANS", "-1ITA
LY", "-1GERMANY", "06MEXICO", "-1ND
RWAY", "SAVE", "-8PHILIPPINES", "
-7THAILAND", "-3TURKEY", "03ARGENT
INA", "X", "Y", "Z"
550 RESTORE 540: FOR b=1 TO 26
560 READ z#: IF b=X THEN LET d
# = z#(3 TO )
570 NEXT b
580 LET D=1: LET nc=2: LET tc=1
: LET q# = "DESTINATION": LET tl=0
590 CLS : GO TO 90
600 CLS : GO SUB 290: PRINT AT
2,13: "BASE "
610 LET l=4: LET q# = s#: GO SUB
110: LET tl=0
620 RESTORE 680: DIM U$(7,9): P
RINT AT 9,11: "WHAT DAY?"
630 FOR n=1 TO 3: READ U$(n)
640 PRINT AT 10+(n*2),2: PAPER
2: INK 9: BRIGHT 1: "":n: "": BR
IGHT 0: PAPER 7: "":U$(n): NEXT
n
650 FOR n=4 TO 6: READ U$(n)
660 PRINT AT 10+(n-3)*2,16: P
APER 2: INK 9: BRIGHT 1: "":n: "
": BRIGHT 0: PAPER 7: "":U$(n):
NEXT n
670 READ U$(7): PRINT AT 18,9:
PAPER 2: INK 9: BRIGHT 1: "":7: "
": BRIGHT 0: PAPER 7: "":U$(7)
680 DATA "SUNDAY", "MONDAY
", "TUESDAY", "WEDNESDAY", "THURS
DAY", "FRIDAY", "SATURDAY "
690 GO SUB 290: PAUSE 0: LET W=
VAL INKEY#: LET C# = U$(W): LET Y#
= U$(W)
700 GO SUB 7000
710 PRINT AT 8,1: C#: "": "
720>PRINT AT 14,10: "ENTER TIME
": AT 16,9: "(24 HOUR MODE)"
730 INPUT "HOUR ": H
740 GO SUB 1110
750 LET V=G
760 LET T=H
770 IF H>12 THEN LET T=H-12
780 IF G>12 THEN LET V=G-12
790 IF H>11 AND H<24 THEN LET
K# = "PM"
800 IF G>11 AND G<24 THEN LET
L# = "PM"
810 INPUT "MINUTES ": M
815 IF M=0 THEN LET M=60
820 PRINT AT 14,1: E#: AT 16,1: E#
830 GO SUB 5180
840 GO SUB 8000
850 LET K# = "AM": LET L# = "AM"
860 IF H>11 AND H<24 THEN LET
K# = "PM"
870 IF G>11 AND G<24 THEN LET
L# = "PM"
880 GO SUB 6000
890 PAUSE P
900 LET M=M+1: IF M>60 THEN LE
T M=1
910 IF M>59 THEN LET H=H+1: LE
T T=T+1
920 IF M>59 THEN LET G=G+1: LE
T V=V+1
930 IF W=7 THEN LET W=0
940 IF H=24 THEN LET C# = U$(W+1
)
950 IF G=24 THEN LET Y# = U$(W+1
)
960 IF H=24 THEN PRINT AT R,1:
C#
970 IF G=24 THEN PRINT AT 18,1
: Y#
980 IF H>24 THEN LET H=1: LET
T=12

```

```

990 IF G>24 THEN LET G=1: LET
V=12
1000 IF H=1 AND H<13 THEN LET T
=H
1010 IF G=1 AND G<13 THEN LET V
=G
1020 IF H=24 THEN LET K# = "AM"
1030 IF G=24 THEN LET L# = "AM"
1040 IF H>12 THEN LET T=H-12
1050 IF G>12 THEN LET V=G-12
1060 IF H>11 AND H<24 THEN LET
K# = "PM"
1070 IF G>11 AND G<24 THEN LET
L# = "PM"
1080 GO SUB 6000
1090 GO SUB 8000: GO SUB 6000
1100 GO TO 830
1110 LET F=(I-J)
1120 LET G=H+F
1130 IF H>24 THEN LET H=H-24: L
ET K# = U$(W+1)
1140 IF G>24 THEN LET G=G-24: L
ET Y# = U$(W+1)
1150 RETURN
5000 DIM H$(24,2)
5010 FOR H=1 TO 24: LET H$(H)=ST
R# H: IF H<10 THEN LET H$(H)=""0
"+STR# H
5020 IF H=24 THEN LET H$(H)=""00
"
5030 NEXT H
5040 DIM G$(24,2)
5050 FOR G=1 TO 24: LET G$(G)=ST
R# G: IF G<10 THEN LET G$(G)=""0
"+STR# G
5060 IF G=24 THEN LET G$(G)=""00
"
5070 NEXT G
5080 DIM T$(12,2)
5090 FOR T=1 TO 12: LET T$(T)=ST
R# T: IF T<10 THEN LET T$(T)=""
"+STR# T
5100 NEXT T
5110 DIM V$(12,2)
5120 FOR V=1 TO 12: LET V$(V)=ST
R# V: IF V<10 THEN LET V$(V)=""
"+STR# V
5130 NEXT V
5140 DIM M$(60,2)
5150 FOR M=1 TO 60: LET M$(M)=ST
R# M: IF M<10 THEN LET M$(M)=""0
"+STR# M
5160 IF M=60 THEN LET M$(M)=""00
"
5170 NEXT M
5180 LET R=8: LET C=14
5190 LET P=3515
5200 RETURN
6000 PRINT AT R,C-1: "": AT R,C+1
0: "":
6010 PRINT AT R+10,C-1: "": AT R+
10,C+10: "":
6020 PRINT AT R,C+4: "OR"
6030 PRINT AT R+10,C+4: "OR"
6040 PRINT AT R,C+14: K#
6050 PRINT AT R+10,C+14: L#
6060 PRINT AT R,C-3: H$(H): AT R,C
+8: T$(T)
6070 PRINT AT R+10,C-3: G$(G): AT
R+10,C+8: V$(V)
6080 PRINT AT R,C: M$(M): AT R,C+1
1: M$(M)
6090 PRINT AT R+10,C: M$(M): AT R+
10,C+11: M$(M)
6100 RETURN
7000 DIM E$(29)
7010 FOR N=8 TO 20
7020 PRINT AT N,1: E#
7030 NEXT N: RETURN
8000 PRINT AT 12,10: "DESTINATION
"
8010 LET l=14: LET q# = f#: LET tl
=1: LET tc=2: GO SUB 110: LET tl
=0
8020 PRINT AT 18,1: Y#: "":
8030 RETURN

```

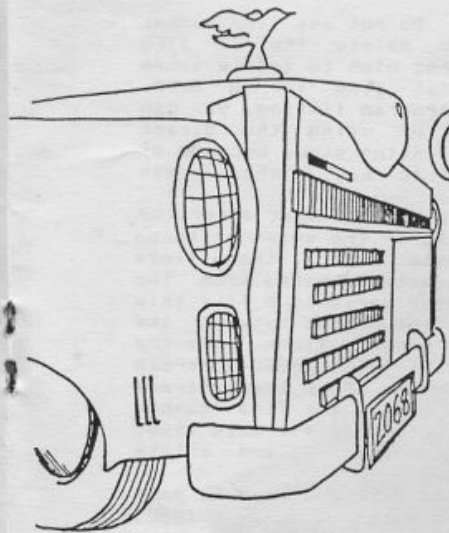

# CLASSY

FRONT  
END

Update  
Paul Bingham

Greetings and salutations! We begin the new year with discussing a bug in Part Four (NOV/DEC issue of TDM). That's right, a bug, and the funny thing is nobody noticed it all this time, not even me. But this publication is blessed with some astute readers like Lou Dooley of Ocala, Florida who was kind enough to write.

It is only one byte, but in machine code, one byte can be the only loose nut you need for a real crash. This byte is located on page 17 of the last issue in Listing 1. Find line 130 (a DATA statement) of Listing One. At the end of the first line is the number 136. See it? Well, he's our bug...it should read 137. Now all the latest copies of "BINGHAM'S BEST" don't have a bug, and those owners of the

early version were all sent cards before Christmas to make them aware of it. But for all of you who type in listings yourselves, you may want to make the change. If not, the ERROR C routine, should you ever use it, could put an extraneous character in memory. If you then rerun the program, this could give you a strange lock-up, a crash, or the like.

Lou also came up with a great little two byte alteration. What it does is solve the dilemma of having to program the USER print calls and the REMS containing all the characters to be printed in two different lines. It can now be all in one line like this:

```
2000 IF USER print THEN REM AT 2, 10;"ABC-123"
```

Here's all you need to do: Find Classy Front End Part 3 in the Sept/Oct '87 issue. On page 20 look for Listing 1. In line 20 (a DATA statement) the second line reads: ,35,119,42,85,92,1,5,...and so on. Change the 85 to 93 and the 5 to 2. That's all there is to it! (Remember all lines must be typed in the new way as shown above once you have made this change. The program will not accept lines written the old way.) This little modification seems to work well. Thanks Lou!

Next issue is dedicated to GRAPHICS and so it seems an appropriate time to jump into the next level of CFE programming: WINDOWS. Until next time, keep working on new ideas for CLASSY. Please feel free to send me any of them or questions you might have. If you wish to use CLASSY but want to avoid all the typing, it is included on my "BINGHAM'S BEST" cassette (along with other machine code and BASIC programs from past articles in TDM). The cost is \$9.95 ppd. My address is: Paul Bingham, PO Box 2034, Mesa, AZ 85214.

"Beyond the User Manual"  
ZX81/TS1000/TS1500.

## CK Type 1000

Earl V. Dunnington

My thanks to Stan Lemke for giving me permission to use his CK TYPE program that I have modified for the smaller Sinclair computers. This gives me the opportunity to present a very practical program, illustrating the use of some of the things covered in my recent "Your RAM Memory" series, and to dispel the myth that only line numbers from 1 to 9999 can be used in Timex Sinclair computers.

Three different versions of the program will be presented. Two BASIC versions, one using line numbers less than 10000, and one using line numbers 10000 and over. Due to the space required, a Machine Code version, compiled from BASIC will be presented in the next episode.

The BASIC versions require at least 2K RAM, and the MC version at least 16K RAM, and the 2040 printer. This program will help in debugging programs typed in from listings if the author has provided a CK TYPE listing made with this or a similar program.

At this point, please read paragraphs 1 to 5 and 8 of Stan's CK TYPE article on page 13 of the MAY/JUNE '87 issue of TIME DESIGNS.

Continuing Stan's illustration labeling, Listing "E" is his CK TYPE program in BASIC as modified for the TS1000/1500. If you do not have "The ZX Compiler" (copyright 1983, Bob Berch, Cinagro Software, 155 Seventh St., Rochester, NY 14609), delete line 9999, as this is for use by the compiler. The variable names had to be changed as the compiler allows only two letters, or one letter and a number designations. I chose to use the first and last letters of the variable names as assigned by Stan. Those readers who do have the compiler

should delete line 9996, as there is no way of continuing the MC program after the screen is filled and you get an error 5/ report (without rewriting the program). Those readers who do not have the compiler should go to the next paragraph without typing in Listing "E". Those who chose to type in this listing should save it to tape with the direct command: SAVE "CKTYPE" then press ENTER. RUN the program in the FAST mode. You should get a listing on the screen and on the printer that agrees with Listing "F".

Many authors have stated that you can only use line numbers from 1 to 9999. This is partially correct, as when typing a program into the computer, the syntax check will only allow the use of these line numbers. By POKEing the first two bytes of a program line that has been stored (High Byte then Low Byte) you can change the original line numbers. See the diagram of how each program line is stored on page 128 of the ZX81/TS1000 and page 155 of the TS1500 User Manuals. There are some restrictions on the use of line numbers, higher than 9999, by this method. I will cover these in my article on the Program Area of the BASIC system at a later date. Once changed to a line number greater than 9999, the line cannot be edited nor can you delete it without POKEing the line number back to 9999 or lower. The reason for changing line numbers, is so that they will not interfere with the line numbers of the program to be typed in from a listing.

Listing "G" is the program used to produce the final CK TYPE 1000 program in BASIC. In order to save memory, line 9999 was deleted and lines 9980



to 9998 of Listing "F" was revised using the program "KRUNCHER 1000" (copyright S&K Software, from RMG Enterprises, 1419 1/2 7th St., Oregon City, OR 97045):

1. Type in Listing "G".
2. Using the direct command: GOTO 9980 operate the program. A CK TYPE listing will be displayed on the screen. When the screen is filled you will get a 5/ error report and the printer, if connected will stop.
3. Check the display or the printout against Listing "H".
4. Press the C key and then press ENTER. The remainder of the listing will be displayed and printed if the printer is on.
5. Check against the rest of Listing "H".
6. After making any corrections, change the 9983 in line 9998 to 10003.
7. Operate lines 10 to 100 of the program by using the direct command: RUN.
8. Delete lines 10 to 100 and LLIST or LIST the program. It should agree with Listing "I".
9. RUN the program and you should get a CK TYPE listing that agrees with Listing "J".
10. Press CLEAR and ENTER. Save the program on tape using the direct command: SAVE "CKTYPE"
11. Determine the total number of bytes in the Program area by using the direct command: PRINT (PEEK 16396+256\*PEEK 16397)-16509 Then press ENTER. The result should be 359. This value will be used when deleting the CK TYPE program lines and should be permanently recorded.

You now have the final BASIC version of CK TYPE 1000 on tape. You must load it before typing a published program listing that has a check type

listing included with it. Do not use line number 9999, as it will be used to delete the CK TYPE program lines. If you do not wish to delete those lines, you may have to use that line for a STOP. Once you have typed in a program listing, you can obtain a CK TYPE listing by using the direct command: GOTO 1000 If the listing stops because of a full screen, press the CONT (C key), then press ENTER.

To delete the CK TYPE lines you must determine the address of the second byte of the start of these program lines. As you found before, these lines occupy 359 bytes. If we subtract 358 bytes from the address contained in the system variable D\_FILE this will give you the address of the second byte of the first line of the CK TYPE program lines. Type the following direct command: PRINT (PEEK 16396+256\*PEEK 16397)-358 Then press ENTER. POKE this address with 15 (decimal). This will change the line number from 10000 to 9999. Now you can delete this line. Continue POKEing 15 to the same address and delete the rest of the lines.

If you have a program on tape and wish to make a CK TYPE listing for it, you must have a "MERGE" utility program, the compiled version loaded above RAMTOP, or type in the CK TYPE program from the listing. If the line numbers will not conflict, this would be easier to do from Listing "E", after deleting lines 9996 and 9999.

We will continue this discussion in the next issue of TDM.

```

LISTING E
9980 LET ST=16509
9981 LET SP=256*PEEK 16397+PEEK
16396
9982 LET BT=ST
9983 LET LE=0
9984 LET LH=0
9985 LET SM=0
9986 LET LE=256*PEEK BT+PEEK (BT
+1)
9987 LET BT=BT+2
9988 LET LH=256*PEEK (BT+1)+PEEK
BT
9989 LET BT=BT+2
9990 LET OD=1
9991 FOR I=1 TO LH
9992 LET SM=(SM+OD+1)+PEEK BT
9993 LET OD=NOT OD
9994 LET BT=BT+1
9995 NEXT I
9996 PRINT LE;TAB 6;"; ";LH;TAB
13;"; ";SM
9997 LPRINT LE;TAB 6;"; ";LH;TAB
13;"; ";SM
9998 IF BT<SP THEN GOTO 9983
9999 RETURN

```

```

LISTING F
9980 : 16 : 1196
9981 : 40 : 2293
9982 : 7 : 599
9983 : 12 : 642
9984 : 12 : 645
9985 : 12 : 657
9986 : 32 : 1874
9987 : 15 : 901
9988 : 32 : 1877
9989 : 15 : 901
9990 : 12 : 774
9991 : 14 : 1041
9992 : 24 : 1407
9993 : 8 : 792
9994 : 15 : 899
9995 : 3 : 412
9996 : 39 : 2076
9997 : 39 : 2056
9998 : 19 : 1767
9999 : 2 : 375

```

```

LISTING G
10 LET START=(256*PEEK 16397+P
EEK 16396)-2
20 LET HIGHBYTE=39
30 LET LOWBYTE=34
40 FOR N=START TO START-358 ST
EP -1
50 IF PEEK N<>118 THEN GOTO 90
60 POKE N+1,HIGHBYTE
70 POKE N+2,LOWBYTE

```

```

80 LET LOWBYTE=LOWBYTE-1
90 NEXT N
100 STOP
9980 LET ST=VAL "16509"
9981 LET SP=VAL "256"*PEEK VAL "
16397"+PEEK VAL "16396"
9982 LET BT=ST
9983 LET LE=NOT PI
9984 LET LH=NOT PI
9985 LET SM=NOT PI
9986 LET LE=VAL "256"*PEEK BT+PE
EK (BT+SGN PI)
9987 LET BT=BT+VAL "2"
9988 LET LH=VAL "256"*PEEK (BT+3
GN PI)+PEEK BT
9989 LET BT=BT+VAL "2"
9990 LET OD=SGN PI
9991 FOR I=SGN PI TO LH
9992 LET SM=(SM+OD+SGN PI)+PEEK
BT
9993 LET OD=NOT OD
9994 LET BT=BT+SGN PI
9995 NEXT I
9996 PRINT LE;TAB VAL "6";"; ";L
H;TAB VAL "13";"; ";SM
9997 LPRINT LE;TAB VAL "6";"; ";
LH;TAB VAL "13";"; ";SM
9998 IF BT<SP THEN GOTO VAL "998
3"

```

```

LISTING H
10 : 53 : 2808
20 : 19 : 1144
30 : 18 : 1098
40 : 34 : 2190
50 : 24 : 2186
60 : 20 : 1154
70 : 19 : 1136
80 : 25 : 1445
90 : 3 : 417
100 : 2 : 348
9980 : 13 : 892
9981 : 31 : 2086
9982 : 7 : 599
9983 : 7 : 762
9984 : 7 : 765
9985 : 7 : 777
9986 : 24 : 1809
9987 : 12 : 859
9988 : 24 : 1812
9989 : 12 : 859
9990 : 7 : 758
9991 : 9 : 1025
9992 : 19 : 1391
9993 : 8 : 792
9994 : 10 : 882
9995 : 3 : 412
9996 : 33 : 1846
9997 : 33 : 1826
9998 : 16 : 1434

```

```

LISTING J
10000 : 13 : 892
10001 : 31 : 2086
10002 : 7 : 599
10003 : 7 : 762
10004 : 7 : 765
10005 : 7 : 777
10006 : 24 : 1809
10007 : 12 : 859
10008 : 24 : 1812
10009 : 12 : 859
10010 : 7 : 758
10011 : 9 : 1025
10012 : 19 : 1391
10013 : 8 : 792
10014 : 10 : 882
10015 : 3 : 412
10016 : 33 : 1846
10017 : 33 : 1826
10018 : 17 : 1439

```

```

LISTING I
A000 LET ST=VAL "16509"
A001 LET SP=VAL "256"*PEEK VAL "
16397"+PEEK VAL "16396"
A002 LET BT=ST
A003 LET LE=NOT PI
A004 LET LH=NOT PI
A005 LET SM=NOT PI
A006 LET LE=VAL "256"*PEEK BT+PE
EK (BT+SGN PI)
A007 LET BT=BT+VAL "2"
A008 LET LH=VAL "256"*PEEK (BT+3
GN PI)+PEEK BT
A009 LET BT=BT+VAL "2"
A010 LET OD=SGN PI
A011 FOR I=SGN PI TO LH
A012 LET SM=(SM+OD+SGN PI)+PEEK
BT
A013 LET OD=NOT OD
A014 LET BT=BT+SGN PI
A015 NEXT I
A016 PRINT LE;TAB VAL "6";"; ";L
H;TAB VAL "13";"; ";SM
A017 LPRINT LE;TAB VAL "6";"; ";
LH;TAB VAL "13";"; ";SM
A018 IF BT<SP THEN GOTO VAL "100
03"

```

# Inside the PC 8300

Bruce C. Taylor



The first impression of the PC 8300, by anyone in love with the Sinclair ZX81/TS1000, has to be a good impression. After all, for only \$30 you have in your hands a ZX81 'clone'. Actually, it's quite flattering for any computer to be cloned, especially one that costs so little.

On the outside, the PC 8300 has some nice features (when compared with the ZX81/TS1000). These features include the LED power on indicator, the RESET button, the sound capability and the "almost real" keyboard.

Inside, the PC 8300 is quite different from its ancestors. I am always accused of "opening the case first" when I see a new product. I had to open the case when the display did not function correctly upon first turning on my new PC 8300. I removed the screws from the bottom half of the case and partially separated the two halves. I noticed there was a signal diode (1N914/1N4148 type) mounted on the circuit board near a '50HZ' marking. I took an educated guess that this diode was for operation in a 50HZ power line environment but not a 60HZ environment. My guess was correct as removal of the diode caused the computer display to work correctly both with TV and monitor. You may be saying, "Wait, the power to the computer is direct current (DC), rectified by the external power supply!" I can only speculate that the video output signal modification is for 50HZ power with and 60HZ power without the diode.

I quickly learned that the wires connecting the keyboard to the main circuit board were not properly soldered. I then had to resolder the wires in order to get the keyboard to properly respond.

I also noticed that the main circuit board was remarkably 'clean', meaning it didn't have very many components present. Of particular note was the lack of clock components, normally

consisting of a crystal and some capacitors and resistors. I noted no chips marked as a 'Z80' CPU. My conclusion was that the Central Processing Unit included the clock and possibly other components on the same chip.

Another disturbing feature of the computer is there is no manufacturer or place of origin marked anywhere. The box and manual also omit any identification. The PC 8300 is apparently an illegal or quasi legal copy of the Sinclair machine.

Anyone can solder together some components and call it a computer. However, the real inside of a computer is what is in the Read Only Memory or operating system. As those who have already used a PC 8300 know, the machine lacks exclusive use of single key entry BASIC words. I find this feature a real step backwards from the original. I have used many expensive desk top computers but none match the BASIC language keyboard entry speed achieved by Sinclair machines. On the other hand, the entry of PC 8300 BASIC statements can run together and the system sorts them out. For example, the operating system recognizes the entry "10FORN=1TO100" as "10 FOR N = 1 TO 100."

The single most outstanding feature of the computer is the reset button which starts a 'warm' reset of the system. A 'warm' reset allows you to reset the computer without dumping the program from memory. This feature is especially good when testing the machine code routines I use in robot control. With an assembly code error on Sinclair computers the keyboard locks up and you have to remove power and reload the program. On the PC 8300, simply press 'reset' to exit the assembly routine and return to BASIC without dumping what is in memory.

The instruction manual is very thick and probably well written. However, I don't read the Far East language the manual uses. There are a few charts and tables in the manual that are readable, because of their arabic numbering and english keystroke legends.

The operating system may have some improvements, but these improvements may cause problems. Comparing the character set/code chart of the PC 8300 with a Sinclair will show the two computers are not 100% compatible. For example, the code for THEN is 64 in the PC 8300 and 222 in the TS1000. Most of the ROM codes match but the few differences will prevent some basic programs running properly.

One of the biggest incompatibilities inside the PC 8300 is the way it assigns internal memory locations. This difference, surprisingly, does not prevent the Sinclair 16K RAM pack from being used on the PC 8300. The primary reason for the compatibility is because the external bus connector on the PC 8300 is pin compatible with the TS1000. This also allows use of



the TS1000 printers and the Budget Robotics & computing RX81 input/output board on the PC 8300. However, even though the external connector is pin compatible, it is not 100% signal compatible. Either electrical characteristics of some PC 8300 signals are different or internal operating system handling of these signals differs from the TS1000. The result is that some peripherals will not work with the PC 8300 without hardware modification. The Budget Robotics Buffered Bus Expansion board is one example.

Now, back to the memory allocation incompatibilities. When writing machine code routines for the TS1000, you can POKE code directly into a 1 REM statement starting at address 16514. This will not work on the PC 8300. For some strange reason, on the PC 8300, this location moves up 793 bytes to 17307. Also, in preparing an empty 1 REM statement on the PC 8300 you can't just enter blank spaces like on the TS1000. Instead, you must enter quotation marks at the beginning and end of the blank statement on the PC 8300.

The PC 8300 is a good machine with both advantages and disadvantages when compared to the Sinclair ZX81 and Timex/Sinclair 1000. Will parts be available if you want to repair a PC 8300? I doubt it. As most have handled the TS1000 repair problem, just toss it and get another. The price is right.

## TIPS ON ZX81/TS1000 COMPUTER REPAIR

Bruce C. Taylor

The following is a brief record of things that go wrong with ZX81/TS1000 computers and how to recognize and fix them.

Your first clue as to what's wrong is what does or doesn't come up on the screen. If nothing comes up on the screen, check to see that the TV and computer have the same channel selected. Suspect a bad power adapter if channel selection is OK. Another possibility is the RF modulator (the shiny box inside the computer), but I have yet to see one of these fail.

To take the computer apart, remove the 3 to 5 screws from the bottom and separate the top and bottom halves. Two of the screws are under rubber feet. You have to do this if you want to fix it. The top half will have the computer printed circuit board attached. The first thing to check is the shiny grounding strip on the bottom of the circuit board. Sometimes one end (the end near the edge connection) breaks away from the circuit board. If so, reposition it and resolder it to the board. In nearly all repairs you will have access the top of the circuit board. Do this by taking the screws (usually 3) from the bottom of the circuit board. After removing the, slowly separate the case top from the circuit board being careful not to damage the keyboard ribbon connections. At this point you have two choices on how to

proceed. If you pull the two keyboard ribbon cables from their connectors, you risk damage. You may (1) tear them or (2) not be able to reinsert them properly without damaging the ends. The risk is either damaging the connections or damaging the connections. One alternative is to set the board and case top on their edges. This leaves a small space between the halves to get at the components on the board. However, you also risk damaging the ribbon connections this way too. This is one reason Budget Robotics sells replacement membrane keyboards.

Now, what will need fixing? If you have damaged keyboard ribbon connections (they get brittle from the heat sometimes), replace the keyboard. However, a common mistake in diagnosing a computer problem is to assume that if the keyboard doesn't respond, the keyboard is bad. If a group of keys in one area of the keyboard are the only ones that don't work, it's a bad keyboard. Replace IC1 if none of the keys work (and the connection is OK) or if keys only fail in a shifted mode. Integrated circuit chip number 1 is one of the two largest chips and always socketed. In fact, IC1 is the most common component to fail.

The CPU (the other large one, marked Z80 on top) is the second most susceptible to failure.

The other IC chips on the board rarely fail. These chips are the ROM (read only memory chip with the operating system inside) and the RAM (random access memory chip). Some machines have one, and some two RAM chips.

That is a corporate dump of the repair experience we have, good luck in your efforts.

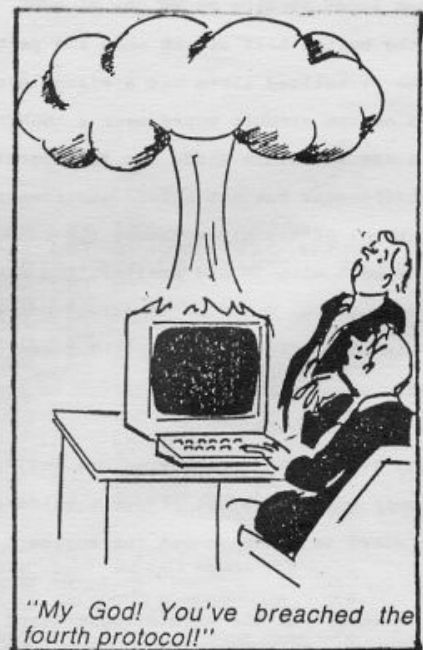

# Spectrum 128k Basic

Michael J. Felerski

Now that more and more Spectrum 128k's are working their way into this country, (and I happen to own one of them) I think the time has come to take a look at 128 Basic. I know what you're thinking--just when you thought you had 2068 Basic and Spectrum Basic figured out and separated, along comes something new that makes you consider becoming just a user. Don't Panic! 128 Basic is a small yet strong step forward in Sinclair programming.

Now for a little background on the Spectrum+ 128K machines. The Spectrum 128K machines come in three versions, The Spectrum +, The +2, and the +3. All three machines operate in a dual mode, either 48 Basic or 128 Basic. An introductory menu is displayed during powerup or reset. This menu asks if you wish to use the tape loader, enter 128 Basic, enter the calculator mode, enter 48 Basic mode, or run the Tape Tester. You select by using the Up and Down arrows to highlight your choice and the Enter key to select it.

Upon choosing 128 Basic mode, the screen is cleared and the Sinclair copyright is displayed at the bottom. 128 Basic is very similar to 48 Basic except that it contains some extra commands. So if you are a wiz at 48 Basic, you should have no trouble writing in 128 Basic. The first thing to know about 128 Basic is that it does not use the famous Sinclair one key for a keyword entry system. Each key word has to be typed in letter by letter. Also noted is that the TRUE VIDEO and INVERSE VIDEO keys are not used in 128 Basic. Inverse effects are obtained by using the 128 keywords INVERSE 1 and INVERSE 0.

In 128 Basic, EXTEND MODE is only used for a few symbols shown above the letters on the keys, such as [ . The GRAPHICS mode works the same except that you can not use the cursor control arrows until you leave the GRAPHICS mode. In addition, color control codes can not be used as in 48 Basic. This means that you can not type EXTEND MODE + CAPS SHIFT and a numeric key to change the color of text or graphics in the middle of composing a line of 128 Basic code. Instead you must use the color keywords. Let it also be noted that some PEEKs and POKES may not work the same in 128 Basic as in 48 Basic.

128 Basic allows the programmer to enter program lines in either upper case or lower case letters. Syntax checking is done in the same manner as in 48 Basic. Editing program lines is quite simple and is done using the cursor keys for movement. If you have the optional Keypad there are several additional cursor operations available. These additional operations are, move cursor right to the beginning of the next word, move cursor up ten lines of the program, move to the end of a program line, etc.

The EDIT key brings up an Options menu that offers the following commands; return to 128 Basic, Renumber, Screen, Print, and Exit. '128 Basic' returns you to the program listing. 'Renumber' alters the line numbers of the current Basic program starting at line ten and incrementing by ten keeping in mind the GOTOs and GOSUBs. 'Screen' causes your Basic program to be displayed on the bottom two lines instead of the whole screen.

This can be useful when you are trying to retain a screen display and view code at the same time. As of yet, I have not found a need for this function. 'Print' is used to dump the program listing to an external printer via the RS232 port within the Spectrum. Note that the ZX Printer or TS2040 is not supported. 'Exit' will return you to the startup menu. Your current program is then stored and can be recalled by reentering 128 Basic. Selecting 48 Basic or pressing the reset button will cause the program to be lost.

The additional memory in the Spectrum+ 128k can be used for storing large machine language programs or as a RAM disk. Of course all of the programs or data stored are lost on power off. The data stored, however is not lost upon execution of the NEW command. The RAM disk commands are the same as cassette commands except that the RAM disk commands must contain an ! after the cassette commands. For example to save a program enter the command, SAVE!"program" LINE 10 . VERIFY is the only keyword not available with the RAM disk. You can get a catalog of all the programs or data files stored in the RAM disk with CAT!. Programs and files may also be erased using the ERASE!"filename" command.

There are two different ways to make music and sound effects in 128 Basic. The first is using the BEEP command. The BEEP command is used in the same way as in 48 Basic. The second way

## TS2068 PERIPHERALS

\*STANDARD KEYBOARD SYSTEM-\$69.95  
Includes case, cartridge port IF card, 42 keys, TIMEX key legends

\*WORD PROCESSOR KEYBOARD SYSTEM  
As above but with 65 keys-\$99.95

\*RGB INTERFACE UNIT \$34.95

\*KEMPSTON JOYSTICK I/F \$24.95

\*SOUND/BEEP BOOSTER UNIT \$41.50

\*CARTRIDGE ADAPTER UNIT \$24.95  
Plug cartridge peripherals into rear edge connector

\*SPECTRUM TWISTER \$39.95  
Plug SPECTRUM Units into TS 2068

\*SPEECH SYNTHESIZER \$39.95

Add \$5.00 S&H for keyboards

JOHN MATHEWSON, 1852 APPLEFORD ST., GLOUCESTER, ONTARIO, K1J6T4



# Lemke Software Development

Quality products for the TS 2068

DESKTOP PUBLISHING: THE ABILITY TO PRODUCE NEWSLETTERS AND OTHER DOCUMENTS OF TEXT AND GRAPHICS HAS JUST BEEN MADE AVAILABLE TO TS 2068 OWNERS...



## PIXEL PRINT NEW PRINT SENSATION!

Lemke Software Development of Wichita, Ks. has just added the PIXEL PRINT Desktop Publisher to their program line!

This ad created with Pixel Print.

- + Single or Twin Columns
- + Variable Size Characters
- + Many Fonts + LOAD CUSTOM Fonts
- + SCREEN\$ Graphics or ICONS
- + Full Size or TS 2040 printer (IBM compatible DOT Matrix)
- + COPY/ERASE/INSERT/DELETE/UNDO only \$19.95 ppd.

## ICON PACKAGE

for the Desktop Publisher

- + 102 ICON Clip Art Pictures
- + ICON Librarian (browse ICONS)
- + ICON Designer only \$19.95 ppd.

SOON: ICON #2 (Fall 1987)  
+ 100 more ICONS  
+ \$14.95 ppd. (no programs)

-- ICONS BY MOUNTAINEER SOFTWARE --



## PIXEL SKETCH AND GRAPHICS EDITOR

- + 32 Column Draw/Edit
- + Extended Color Mode Draw/Edit
- + 64 Column Mode (Hi Resolution)
- + Merge Screens
- + Full Screen (Window) Edit
- + ENLARGE/Shrink/Rotate/Mirror
- + TEXT (uses FONT PACKAGE too!)
- + Draw/Erase/Dash
- + IBM Dot Matrix Full Size and TS 2040 Printers
- + UNDO (oops!) function
- + Digitize (display bytes) only \$19.95 ppd.

## FONT PACKAGE

for the Desktop Publisher

- + 5 New Fonts  
HEADLINE Adventure  
IBM Outline  
MICR SX5
- + Font Designer and Librarian only \$19.95 ppd.  
--- Font Package #2 ---
- + 6 More Fonts  
Helvetica Ritz  
Times Sinclair  
Block Block GrandPrix  
only \$14.95 ppd.  
(no programs!)
- FONTS BY MOUNTAINEER SOFTWARE --
- Font Package #3 ---
- + 6 More Fonts  
Cursive Thespian  
MICROGRAPH Western  
STENCIL Wideload
- + 26 Graphic Borders
- + 12 Masthead (Banner) Designs  
only \$19.95 ppd.  
(no programs!)



## Checkbook Budget Master



Checkbook Database and Budget Analysis Program

- + 800 Check Database
- + Add/Delete/Recall Checks Fast
- + Categorize Expenses
- + Compare Income vs Expense
- + Great at Tax Time!  
only \$19.95 ppd.

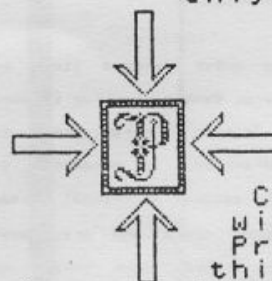

Pixel Print  
TASWORD  
Utility

Create your TEXT file with your TASWORD Word Processor and convert this to the Pixel Print format. Select any Font... locate and merge ICONS too!  
only \$19.95 ppd.

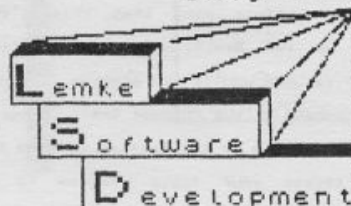

S D Lemke  
2144 White Oak  
Wichita, Ks.  
67207



is through the use of the PLAY command. The PLAY command is similar to the SOUND command on the TS2068 except that the syntax is a bit different. The PLAY command has the following syntax: PLAY a\$,b\$,c\$. The strings contain the commands/notes that are to be played. Since the 128 has a three channel sound synthesizer, up to three strings can be PLAYed as in the example. In addition to this, the Spectrum+ 128K is MIDI (Musical Instrument Digital Interface) compatible. This means that you can connect the 128 to an electronic keyboard that is also MIDI compatible with the proper cable. Thus you can control external devices through the interface using the proper commands within a PLAY command string. The following is a PLAY command summary courtesy of Sinclair Research's ZX Spectrum 128 Introduction guide:

String entry:	Function:
c-b or C-B	Gives pitch of note within current octave range.
\$	Flattens note following it.
#	Sharpens note following it.
0	Followed by number 0 to 8 sets current octave range.
1-12	Set length of notes.
&	Denotes a rest.
N	Separates two numbers.
V	Followed by a number 0 to 15, sets volume of notes.
W	Followed by a number 0 to 7 sets volume effect.
U	Turns on volume effect in any string.
X	Followed by a number 0 to 65535, sets duration of volume effect.
T	Followed by a number from 60 to 240 sets tempo of music.
( )	Enclose repeated phrase.
! !	Enclose a comment.
H	Stops a PLAY command.
M	Followed by a number 1 to 63 selects channel.
Y	Followed by a number from 1 to 16 turns on a MIDI channel.
Z	Followed by a number sends that number as a MIDI programming code.

A typical string may look like this: 10 LET a\$="M56W201NBC":  
PLAY a\$: PAUSE 25 . To a programmer, the TS2068 SOUND command may seem less complicated. To a musician, the 128 PLAY command may make more sense. In any case, the major strength for the Spectrum+ 128k is the MIDI interface.

After playing with the 128 Basic, I have found it to be a fine forward step in Sinclair computing. I recommend to anyone that has the opportunity to try some serious 128 programming to do so, and if your not careful, you might just get the itch to purchase a Spectrum+ 128k to complete your collection.

TS2068  
REVIEW

# Tomahawk

D. FRANSON

Tomahawk is a flight simulator program from Digital Integration, the people responsible for Fighter Pilot and Night Gunner. However, Tomahawk is different from any other flight simulator available for the T/S 2068 or Spectrum.

To begin with, you're piloting a U.S. Army AH-64A Apache Advanced Attack Helicopter. Flying a helicopter involves a significantly different set of aerodynamic rules than does flying a light airplane or even a jet fighter. For example, applying power doesn't automatically propel you forward, but

will propel you straight up! Also, any rolls exceeding 90 degrees are disastrous, since helicopters lack the large wing surfaces that provide the lift necessary to exit a roll.

In addition to the unique challenge offered by the controls, Tomahawk provides several options for game play. Since the helicopter is meant for ground and air attack, the four game scenarios from which you can choose all involve destroying enemy forces. In scenario

one (Training Mode) you simply have to clear one map sector of all enemy ground forces (tanks and guns) and return safely to a landing pad. In scenario two you must clear four sectors of enemy ground forces, except in this instance the enemy returns your fire. Scenario three places you in the middle of the map, which you must liberate by destroying the enemy in all sectors. In scenario four you and the enemy hold equal amounts of territory and you must support your own ground forces while attacking your foe. The map is



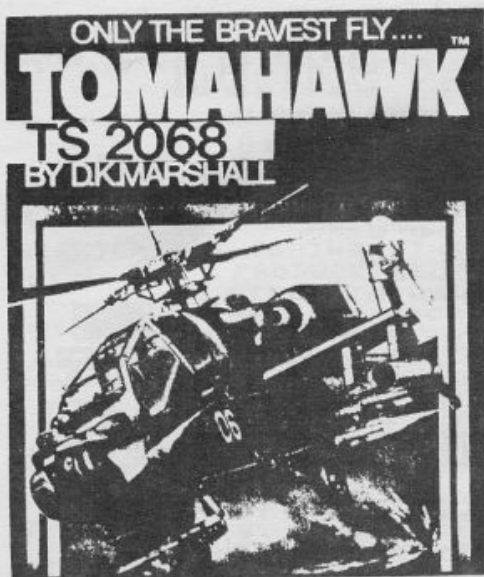

approximately 12 by 16 sectors in size. In all the scenarios you may specify other options such as day or night, cloud ceiling, crosswinds and turbulence, and your pilot rating. In addition to the enemy's ground forces (8 to a sector), you must also contend with enemy helicopters.

So what kind of armament are you carrying to accomplish this destruction? Well, you have lots of cannon rounds, which have a range of 2000 feet. You also have rockets with range of 4000 feet. But best of all you have laser-guided missiles, with a range of approximately 3.1 miles! These buggers are very nasty-- you simply pass the sight over the target, the laser guidance locks in, and a press of the stick button blows the enemy off the map. Lest you think all that armament makes things too easy, note that you can fire only eight laser-guided missiles before you must land at a pad (not an easy task) and get more.

Now I realize this review is starting to sound a bit martial and militaristic, and before you all start calling me "Rambo" let me tell you about the best feature of Tomahawk. **THE GRAPHICS!** Yes, we're talking real simulation graphics here. Over 7000 ground objects, including buildings, lakes, trees, mountains, field guns, tanks, landing pads, and more. The realism provided by these detailed graphics is unprecedented. No more flying around

for ten minutes, seeing only sky and horizon. The graphics in Tomahawk make it the kind of program you show to non-T/S users, and say "Look! This is what my computer can do!"

How good is Tomahawk? Good enough to keep me to five hours of sleep a night for the first week I used it. Good enough to make me long for more free time in which to play it. Good enough for me to hypothesize that, if I didn't already have a T/S 2068, I'd immediately go out and buy one after seeing Tomahawk, just so I could run this program. The best flight simulator for any eight-bit computer! Better than Microsoft's Flight Simulator for the IBM PC! They don't get any better than this.

Tomahawk is available for the Spectrum or the 2068. T/S 2068 users owe a great debt to Knighted Computers, who secured the rights to Tomahawk and converted it to run on the unmodified T/S 2068. The program is available from Knighted for \$16.95:

Knighted Computers  
707 Highland Street  
Fulton, New York 13069

ZX81/TS1000  
REVIEW

## ZX-TERM \* 80

Gary Lessenberry

I admit that when I heard there was a new terminal program for the TS1000 computer, I was unimpressed. When I heard that it required additional hardware before it could be used, I experienced flash backs of my \$60 venture with ZTERM and my TS2068! But, after using this program, I must say that no single terminal package for any Timex Sinclair computer has impressed me the way that ZX-TERM\*80 has. It is a very sophisticated terminal program that is versatile and user-friendly. It is what everybody wants in a terminal program.

Beware! This program will not operate by itself. To use ZX-TERM\*80 you must have a SCRAM board, a 16K RAMpack, and either a TS1000/ZX81 or a TS1500. No, a PC8300 cannot run ZX-TERM\*80, even with the improved ROM from Fred Nachbaur. The SCRAM board is a non-volatile RAM that is used for the high resolution graphics. The Hunter Board can be used as a replacement for the SCRAM, but some hardware modification is required. The ZX-TERM\*80 documentation explains how to perform the Hunter Board modification. Your TS1000 may also require a simple modification as well. However, since the TS1500 is an upgraded version of the TS1000, you need not perform any hardware modifications to it, to use ZX-TERM\*80. You should realize that even though the TS1500 already has 16K of RAM onboard, it will still require a 16K RAMpack.

I will avoid trying to completely walk you through this program. Instead I will try to highlight the features and handicaps of this terminal package. The first and most important feature of any software package (as all MTERM users will testify) is the documentation. ZX-TERM\*80 has an excellent documentation package. It is so thorough that when I first looked at the 42 page manual, I wanted to put it down and go straight into the program. I did however, find that reading it first saved me a lot of time and trouble when actually using the program. This manual is very user friendly and it carefully walks the novice through the program and into the world of telecommunications.

Hardware wise, this program is written to interface with both the Westridge (TS-2050) and Byte Back (MD-2) modems. I was only able to test it on the TS2050. It uses the 2040 (and Alphacom 32) printer for hardcopies. However, a full size 80 column printer can be selected to work with the following printer interfaces: Aerco, JLO, Tasman, Memotech, Ener-Z Report Generator, or Eprom Services. The program was written with the consideration of adapting it to the A&J Micro Drives, or the Aerco, Compusa, and Larken floppy disk interfaces. For some of these devices, minor hardware and software modifications are required and the documentation addresses this subject. This software will allow for the use of a 64K RAMpack or additional NVM (non-volatile memory) devices that

total up to 64K. This program will not work with the Mindware MW-100 printer or any 32K RAM that are fully decoded.

This terminal program is packed full of features that I never expected to find when telecomputing on a TS1000. These features include:

1. A high resolution display that allows upper and lower case letters.
2. Selectable display widths of 40, 60, or 80 columns.
3. Adjustable sized windows.
4. Xmodem file transfer protocol.
5. ASCII capture buffer.
6. Interface driver for continuous printing on an 80 column printer.
7. Easy back up of the software.

The screen display was the greatest selling point of this program. It can be configured for three windows which display user options in the top window, outgoing data in the middle window and incoming data in the bottom window. The top window contains the following user options: Save Toggle, Echo Toggle, Control, U/D Load, View Data, Modem Control, Display, and Initialize. The sizes of the middle and bottom window can be easily adjusted while online. I personally preferred a narrow middle window and a large bottom window. You can also choose a single window configuration that shows both out going and incoming data, without displaying the user options. Of the two configurations, the three window one was my favorite. Another display option is the number of columns. The 40 column mode was easy to read. However, most bulletin boards operate greater than forty columns, and my display couldn't provide justice to their clever screen displays. The 60 column mode requires the use of a monitor with the computer (no TV). Using a composite monitor, the 60 column display was very readable. In the 80 column mode, even with a monitor, I found the display to be too closely squeezed together on the screen to be readable. After using the 80 column display for 15 minutes, my eyes were tired and the effort of reading took away the pleasure of my telecomputing.

The keyboard has been defined as a true terminal keyboard. You have both upper and lower case letters, as well as all of the required punctuation (the available punctuation is #") (# = + - >< \* / ? ; : ' ^ ! \ \_ [ ] @ & , . ). Please note that fifty percent of these symbols are not part of the normal TS1000 repertoire. There is no provision

for a CAPS-LOCK mode (all capital letters) with this program. The keyscan can be modified offline by poking an address to make it scan as fast or slow as you desire. You will probably notice that there is no cursor, and therefore it is difficult to identify when you have typed a space. There is another POKE available that will cause three underlining dash's to be displayed on your screen in place of a space. These dash's are not transmitted to the host computer. All POKES that are mentioned in this review are in the software documentation.

The online operation of ZX-TERM#80 is quite easy. There is not an "auto-dial" function in the software. Therefore, you must manually dial the host system and start your carrier when it answers. Due to the expanded symbology of this program, you are able to enjoy most of the text that is sent without all of those annoying blocks of garbage that were created on other previous TS1000 terminal programs, when they couldn't identify an incoming symbol. File transfers are very easy using this program. I was able to do file transfers with a TS2068, an Apple, a Tandy 1000, and an IBM 386. All uploads and downloads are done in xmodem protocol at 128 bytes per block. During the transfer, your screen displays the data and provides alerts for when a bad block is transferred, before the block is repeated.

In conclusion, I believe that this is and will remain as the best terminal program for the TS1000 family of computers. The documentation is outstanding and the manufacturer's support for their products, has an excellent record. The loading, set-up and operation of the program are virtually self-explanatory. This program is a must for anybody who really wants to enjoy telecommunications.

ZX-TERM#80 is available from Silicon Mountain Computers, C-12, Mtn. Stn. Group Box, Nelson, B.C., V1L 5P1, Canada, and also from Grey and Clifford Computer Products, PO Box 2186, Inglewood, CA 90305.

## CORRY COMPUTER

P.O. Box 5607; Glendale, AZ 85312-3607... Phone: 602-978-2302...  
Stop by and see our new store:  
15224 N. 59th Ave. #4; Glendale

## Your Complete Sinclair Dealer... SINCE 1982!

NEW SHIPPING CHARGES: Under \$50 add \$1 s/h; Under \$90 add \$2 s/h; Under \$130 add \$3 s/h; Under \$180 add \$4 s/h; Under \$200 add \$6; Over \$200 add \$8 s/h. NEW PHONE HOURS: 9 to 6 M-F; 9 to 3 Sat.

Write for a free Catalog for QL or Times/Sinclair. Looking for something? Give us a Call...

### TS 1000 SOFTWARE

4 FOR \$40.00...3 FOR \$30.00...2 FOR \$20.00

For a complete list...write for catalog

Matrix Planner	Pilot	Multiple Choice
Word Test	Hangan	Forecast/Graphs
Flt. Manager	Red Alert	Allen Invasion
T/S Destroyer	Cambler	Home Asset Mgr.
Cosmoetry I	UU Calc	Organizer (AuFile)
Inventory	Home Improve.	

#### BOOKS

1000 Basic Book...\$3.95	UuCalc/File Bk...\$6.95
Ins & Outs of 1000 \$5.95	and more...WRITE
Powerful Projects for your T/S.....\$6.95	
Compt. I/F Tech. in Science for T/S.....\$6.95	
Understanding your ZX81 ROM.....\$7.95	

#### HARDWARE

We still have T/S 1000's for.....	\$24.95
16k RAM Packs.....	\$19.95
32k RAM Packs.....	\$34.95
64k RAM Packs.....	\$49.95
Mindware Printers.....	\$24.95
T/S 1000 Computer Pad.....	\$ 3.95
2040 Printer Paper for 3 rolls.....	\$ 6.95

Call for Prices on:  
MemoText, MemoCalc and HiRes Graphics I/F

### SPECTRUM SOFTWARE

ROBINSON'S COIN-OP HITS.....\$13.95  
Five Games in one package. Includes: Green Beret, Mikie, Via An Kung Fu, Hypersport, Ping Pong.  
THATS ONLY \$2.79 PER GAME!!

HIT-PACK 6.....\$17.95  
Six Comics for one price. Includes: 1942, Duet, Jet Set Willy 2, Fighting Warrior, Split Personality, Antirad.

THATS ONLY \$2.99 EACH!!

FIVE STAR GAMES.....\$17.95  
Six Games in the box. Includes: Allen Highway, Dandy, Cauldron 2, Quazatron, Strike Force Cobra  
ONLY \$2.99 PER GAME!!

Sinclair User Magazine.....	\$4 ea.
Computer and Video Games Magazine.....	\$4 ea.
T/S 2068 Basics and Beyond.....	\$8.95
2068 Beginners/Intermediate Guide.....	\$8.95
2068 Intermediate/Advanced Guide.....	\$8.95
Powerful Projects for your T/S.....	\$6.95
Compt. I/F Tech. in Science for T/S.....	\$6.95

#### HARDWARE

ROM Switch (turn your 2068 into Spectrum).....	\$35.95
Gamesmate Joystick Adapter.....	\$16.95

### QL SOFTWARE, ETC.

Oxford Trivia Game.....	\$14.95
Concept 3D - 3D CAD Program.....	\$29.95
Locksmiths - 'Clone' Prog. MDW to MDW.....	\$19.95
4Matter/Locksmiths - MDW to FLP.....	\$39.95
Sidevinder - Mono Screen Dump.....	\$19.95
Metacomco Assembler.....	\$52.95
QSpall - Spelling Checker.....	\$14.95
Tycoon - Can you make Millions.....	\$14.95
QL Service Manual - Repair Tips.....	\$19.95
Test Cartridge + Cable.....	\$14.95
Artificial Intelligence on QL (book).....	\$12.95
Thompson Case - hold 12 MDWs.....	\$ 2.50
5.25 DSDD Mitsubishi Single Drive.....	\$169.95
MonoChrome Cable.....	\$14.95
QL World Magazine.....	\$ 4.00
TRUMP CARD - 768k, Disk I/F, Plus.....	\$309.95
5.25 DSDD Mitsubishi Dual Drive.....	\$269.95
QL Report 1 Year Subscription.....	\$15.00
RGB Monitor Cable.....	\$16.95
Single Disk Drive Cable.....	\$19.95
Dual Disk Drive Cable.....	\$24.95
QFlash Toolkit.....	\$19.95
QL Dust Cover.....	\$11.95
RS232 Cable.....	\$16.95
West - Textual Adventure.....	\$14.95
Graphic Toolkit.....	\$24.95
Nucleon.....	\$19.95
Wanderer (RGB Monitor Only).....	\$19.95



# Serial Port Driver

John M. Bell

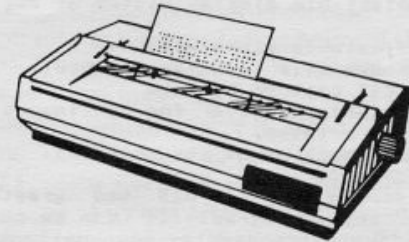

Many experimenters who converted a surplus 2050 modem board to a serial port have been unable to use the interface to drive a printer due to the lack of commercial software. The BASIC program listed at the end of this article generates a Machine Code program that will drive a serial printer through the modified modem. The driver software generated by the program will run on a TIMEX 2068 with or without a SPECTRUM ROM replacement. It should also run on a SINCLAIR SPECTRUM but has not been tested on this machine. The program will not run on any of the ZX-81 series computers or their clones.

The most difficult part of using this program is typing it in. Since it is very easy to mis-type a character in one of the forty-two data statements, an error checking routine has been built into the BASIC program. When the program is run a warning is printed on the screen if a checksum of the data statements is not

correct. The program then stops so the error can be found and corrected. However, it does not check for typing errors elsewhere in the program, so save the program after it has been entered but before it is run. If the computer crashes due to a typing error, the program can be reloaded and the error corrected without lengthy re-typing.

When the program runs it displays the byte number of the machine code it is currently POKEing. It takes about a minute to POKE all 420 bytes. The user is then asked for the serial parameters required for the printer. This information can be found in the printer's manual. Keep in mind that most serial printers have configuration switches on the back. Check to make sure they are set according to the parameters entered at the prompts. The first prompt asks the user to enter the desired baud rate. Enter 300 or 1200 to match the printer's baud rate. A prompt for the type of parity the printer requires is now displayed, enter "E" for even, "O" for odd or "N" for no parity checking. The program then asks for the number of bits in each character sent to the printer, select 7 or 8. At the next prompt enter the number of stop bits required by entering a 1 or 2. The serial protocols have now been set, but more information is required by the program.

Several options for the printer driver's operation will now have to be selected. The next prompt asks the user to enter a "L" for LLIST or a "P" for LPRINT software. For general purpose use supporting TAB, AT, LLIST and LPRINT commands, enter a "P". The "L" option is if the software is for LLISTING programs only. If a "L" is entered, and the program line being printed is longer than the selected printer width, it will be indented when it continues on the next line. The "L" option was selected when the program listing for this article was printed. Notice that it is easier to read and debug programs listed this way. The next prompt asks for the line length. This is the number of characters to be printed on each line, not the width of the printer. If desired, 32 can be entered so the printed copy matches the listing on the screen of the computer. Next enter the number of spaces each line should be indented at the start of each printed line. This indent allows listings to be centered on the paper. Select any number from 0 to one less than the printer's width. Make sure the selected line length and indent, when added together, do not exceed the maximum number of characters per line that your printer will allow. If this limit is exceeded, the printing will not format properly. The last prompt asks if the UDG markers should be disabled. If "Y" is selected, UDG characters will be printed as capital letters A through U. If "N" is selected the capitals will be printed with a

The article How To Convert A Surplus WC2050 Modem Into An RS-232 SERIAL INTERFACE For Your IS1000/1500/2068 appeared in the MARCH/APRIL '86 (Volume 2, Number 3) issue of TIME DESIGNS. Copies of that back issue are still available for \$3.00 postage paid, or the whole set of six Volume 2 issues are priced at \$17.00 pdd.

RS-232/WC2050 Modem Conversion Kits are still available from Zebra Systems, 78-06 Jamaica Ave., Woodhaven, NY 11421, (718) 296-2385. Price is \$19.95 plus \$3.00 S&H (total order).

Surplus WC2050 Modem boards (fully-populated) are available from Grey & Clifford Computer Products, PO Box 2186, Inglewood, CA 90305. Write for prices.

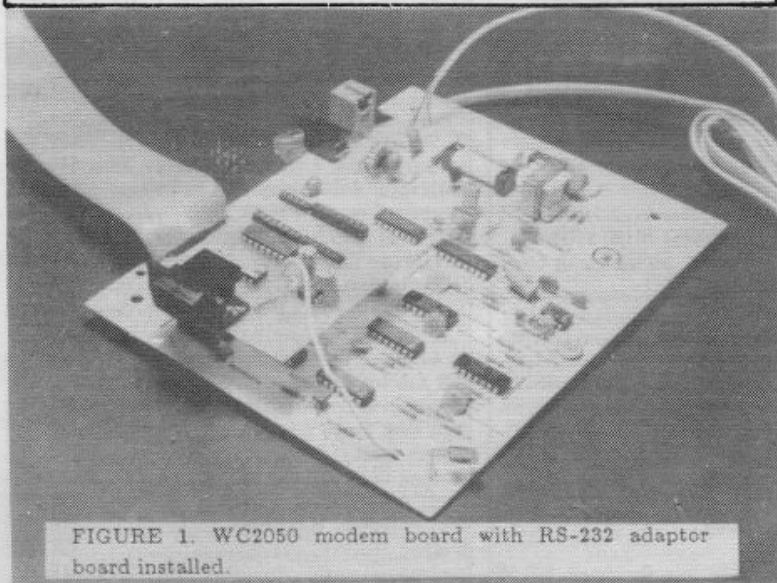

FIGURE 1. WC2050 modem board with RS-232 adaptor board installed.

slash through them, signifying the characters are UDGs and not letters.

The program now stops with the message "CONFIGURATION COMPLETE, SAVE CODE NOW". If desired, the driver code can be saved as described in the next paragraph, but it can be customized even further. The driver software has a "translation table" for the graphic characters. (CHR. CODES 128 through 143.) This table stores the codes that will be sent to the printer when a graphic character is to be printed. This translation allows the user to poke the code of the printers equivalent character in the appropriate location so graphic characters will be printed correctly. The table is 16 characters long and starts at location 65287 in the computers memory. Page 242 in the TIMEX 2068 manual shows the characters and their corresponding codes. Check your printers manual to find the matching code for each character. Note that the driver has the TIMEX character codes stored in this table, the user must poke different codes in this 16 byte area for the translation to take place. There are also four more locations to poke the printer's code for a character. Poke 64967 with the printer's code for the copyright symbol. Poke 64976 with the code for the printer's equivalent of TIMEX character #94, the "arrow up". Poke 64985 with the code for the British pound sign and poke 65013 with the printer's "backspace" code. The custom LLIST/LPRINT code can now be saved to tape or disk. The driver is 420 bytes long starting at location 64900 in the computers memory. As an example, the code can be saved to tape using [SAVE "LLIST" CODE 64900,420]. Save several copies of the code and be sure not to record over the BASIC program that generates the code. Once the print driver code is saved, the program can be run again to configure the machine code differently.

The print driver is now ready to be used for the intended application. To load the program into the computers memory, reserve room for it with the command [CLEAR 64899]. Then load the driver by entering [LOAD "LLIST" CODE]. Once the program loads and the printer and interface are turned on, enter [RANDOMIZE USR 64900] to initialize the code. The LLIST and LPRINT commands now send data to your serial printer. It should work like the TIMEX thermal printer except it leaves spaces over the page breaks in tractor feed paper for better readability.

There are several "tricks to using the driver software. The Formfeed character can be used to advance the paper a full page. Use the command [LPRINT CHR\$ 12] instead of using the paper advance knob on your printer, if you do use the paper advance knob, the driver loses track of it's location on the page. The driver can be re-initialized at any time by entering "RANDOMIZE USR 64900". This resets the driver so another listing can be printed on a new page while keeping the line count and page breaks for the new listing correct. If your printer has features that can be accessed by sending it control codes, they can be sent one at a time by POKEing the code at location 65278 and then entering a RAND USR command. The following BASIC statement will send the escape character to the printer [POKE 65278,27: RANDOMIZE USR 65277]. Repeat this command for each code to be sent, just remember to change the 27 to the required code. Users with an AERCO compatible parallel interface can also use the driver software by replacing lines 50 and 51 in the BASIC program with the next two lines.

```
[50 DATA "8DBE8FD87FCB6720CAF1"] & [51 DATA "D37F000000DB7FC80000"]
```

The BASIC program lines 1170 through 1280 should be deleted. They are only necessary for a serial printer.

## SERIAL PORT PRINT DRIVER



```
1 REM LLIST/LPRINT DRIVER
2 REM FOR 2050 SERIAL PORT
3 REM PUBLISHED BY
4 REM -TIME DESIGNS MAGAZINE-
5 REM WRITTEN BY J. BELL
10 DATA "3E7BD3773E37D377AF32"
11 DATA "03FF3202FF0606CD63FE"
12 DATA "10FB2A4F5C110F001911"
13 DATA "ABFD732372C9ED7305FF"
14 DATA "2104FFCB56C20DFEFA5"
15 DATA "D2A0FEFE90D240FEFE80"
16 DATA "3071FE7F20053ECBC3D5"
17 DATA "FEFESE20053EA4C3D5FE"
18 DATA "FE6020053EC3C3D5FEFE"
19 DATA "7B3805D67AC3A0F5FE20"
20 DATA "D2D5FEFE0CCAC1FEFE08"
21 DATA "20053E08C3E6FEFE0DCA"
22 DATA "63FEFE172805FE162801"
23 DATA "C92104FF3606C92104FF"
24 DATA "CB4E2003CB96C9F5AF32"
25 DATA "03FF3E0DCDEBFE3E0432"
26 DATA "04FFF12101FF86FE00C8"
27 DATA "C5471828C92107FF1600"
28 DATA "D6805F197EC3D5FED62F"
29 DATA "CDD5FE3E08CDF0FD3E58"
30 DATA "C3E6FECD63FECD5FE6C9"
31 DATA "00C506053E20CDD5FE10"
32 DATA "F9C1C93E003203FF3A02"
33 DATA "FFF3C28063C3202FF18"
34 DATA "OD060CCD82FE10FB3E06"
35 DATA "3202FFC93E0DCDE6FE3E"
```

```
36 DATA "0ACDE6FEAF3203FF3A01"
37 DATA "FF4F0C0DC83E20C5CDD5"
38 DATA "FEC118F5219800D6A4CB"
39 DATA "7E2328FB3D20F8CDD3FE"
40 DATA "7ECDD5FE23CB7E28F77E"
41 DATA "CBBFCDD5FE18123A02FF"
42 DATA "473E429047C5CDB2FEC1"
43 DATA "10F9C38CFD3E20F53A03"
44 DATA "FFF46D44FFE3A03FF3C"
45 DATA "3203FFF1F5CDECFE182B"
46 DATA "3E7FDBFE1FD83EFEDBFE"
47 DATA "1FD8ED7B05FFC93EFF18"
48 DATA "E50000000000080B182"
49 DATA "838485868788898A888C"
50 DATA "8DBE8FD877E6802BCADB"
51 DATA "77E601CAE7FEF1D373C9"
1000 REM THIS POKES THE CODE
1010 CLEAR 64899
1020 LET byt=0
1030 LET codloc=64900
1040 FOR a=0 TO 410 STEP 10
1050 READ a$
1060 FOR b=1 TO 20 STEP 2
1070 IF CODE a$(b)<58 THEN LET
c=16*(CODE a$(b)-48)
1080 IF CODE a$(b)>64 THEN LET
c=16*(CODE a$(b)-55)
1090 IF CODE a$(b+1)<58 THEN L
ET c=c+(CODE a$(b+1)-48)
1100 IF CODE a$(b+1)>62 THEN L
ET c=c+(CODE a$(b+1)-55)
1110 POKE (a+INT(b/2)+codloc),
c
1120 PRINT AT 5,5;"BYTE NUMBER;
";a+b/2+.5
1130 LET byt=byt+c
1140 NEXT b
```

```
1150 NEXT a
1160 IF byt <> 56435 THEN CLS :
PRINT "TYPING ERROR, CHECK
DATA": STOP
1170 REM THIS CUSTOMIZES
1180 INPUT "BAUD RATE; 300/1200
";b$
1190 INPUT "EVEN, ODD OR NO PARI
TY; E/O/N ";p$
1200 INPUT "NUMBER OF BITS; 7/8
";n$
1210 INPUT "NUMBER OF STOP BITS;
1/2 ";s$
1220 LET byte=74
1230 IF b$="1200" THEN LET byte
=byte+1
1240 IF n$="8" THEN LET byte=by
te+4
1250 IF p$="E" THEN LET byte=by
te+48
1260 IF p$="O" THEN LET byte=by
te+16
1270 IF s$="2" THEN LET byte=by
te+128
1280 POKE 64905,byte
1290 REM CONFIGURES SOFTWARE
1300 INPUT "LLIST or LPRINT L/P
";a$
1310 IF a$="L" OR a$="L" THEN P
OKE 65110,201
1320 INPUT "Line length ";len
1330 POKE 65242,len
1340 INPUT "Spaces to TAB ";tab
1350 POKE 65281,tab
1360 INPUT "DISABLE UDG MARKERS?
Y/N ";a$
1370 IF a$="Y" OR a$="Y" THEN P
OKE 65093,201
1380 PRINT "CONFIGURATION COMPLE
TE";";"SAVE CODE NOW"
```



**Have you just purchased one of those new, low-priced Sinclair QL's??**

**Then you need the most comprehensive and up-dated source of information available...**

**The excellent new book written in plain English for every QL owner, by the internationally acclaimed author, Mike de Sosa.**

**TAKING THE *QUANTUM LEAP*  
THE LAST WORD  
ON THE SINCLAIR QL**

**\$26.00**

TIME DESIGNS  
29722 Hult Rd.  
Colton, Oregon 97017

# QL VAL STRING FUNCTION

ROBERT D. HARTUNG

A long time ago (TDM March/April '86) I saw a note by Mike de Sosa on the lack of the VAL string function on the QL. At the time I didn't have one, but with the recent price cuts I've added a QL to my "home for orphan computers". Although I ordered one with software and QL User Guide, it came sans manual (later received), so I was digging through all my old Sinclair mags for info when I ran across Mike's comment again.

No doubt other users have found purely software approaches since then, although I have found no published ones in my non-QL specific mags except the one Mike gave which utilizes Microdrive commands. The problem seems to be that while SuperBASIC does correctly interpret the value of an expression discretely entered as a program line, for example:

```
LET a$=2^3*PI or LET a=2^2*PI
```

It seems to "see" only the first item (2) if the same expression is entered in response to INPUT a:

```
LET a$=a: PRINT a$
```

While it is a clumsy substitute for what can be done so routinely with "lowly" TS1000/2068 BASIC, the following process will give the correct output for an expression entered as the definition of either a numeric variable or as a string variable definition without quotes or asterisks:

```
10 expr = 0 : REM or expr$ = 0
20 WHEN ERROR
30 RETRY
40 END WHEN
50 CLS : CLS #0 : PRINT "expr = "; ex
pr: PRINT "Enter expression, then r for
result"; EDIT 10 : STOP
60 DEFine PROCedure r
70 RUN
80 END DEFine r
```

## Advanced Technology Computers from SHARP'S

**Z88**  
**Battery-Powered  
Laptop Computer**  
*with built-in software*

**\$479.95**

**QL**  
**Computer**  
*includes PSION s/w*

**\$129.95**

*We also carry accessories for the Z88.*

We carry **ALL** hardware and software lines for the Sinclair QL. Compare our prices. VISA and MASTERCARD accepted (3 % surcharge).

**WRITE FOR FREE CATALOG**

**Sharp's, Inc.**

Rt. 10, Box 459  
Mechanicsville, VA 23111  
(804) 746-1664 or 730-9697

```

HH HH AAAA PPPP PPPP YY YY
HH HH AA AA PP PP PP PP YYYY
HHHHHH AAAAAA PPPP PPPP YY
HH HH AA AA PP PP YY
HH HH AA AA PP PP YY

```

```

NN NN EEEEE WW WW YY YY EEEEE AAAA RRRR !!
NNN NN EE WW WW WW YYYY EE AA AA RR RR !!
NNNNNN EEEE WWWWWWWW YY EEEE AAAAAA RRRR !!
NN NNN EE WW WW YY EE AA AA RR R
NN NN EEEEE W W YY EEEEE AA AA RR RR 00

```

**FROM RMG ENTERPRISES!**

HERE ARE A FEW NEW PRODUCTS FOR THE NEW YEAR!

- RMG#764 LARKEN 256K RAMDISK PACKAGE-(2068)-----ONLY \$130.95+3PH  
Now YOU can have 256K of NONVOLATILE RAMDISK space on your 2068! Available 2/88. Call for info.
- RMG#760 PLANET FINDER----(S/W)(2068)-----ONLY \$ 14.95+2PH  
Here is a great way to learn about the Solar System!  
Many nice features. Shows orbits, tilt angles and even what you would weigh on Pluto!
- RMG#761 CREATIVE GRAPHICS & SOUND-(S/W)(2068)---ONLY \$ 12.95+2PH  
With this one you can create your own graphics and music or sound from the same program.
- RMG#763 ARROW-QL SOUNDESIGN-----ONLY \$ 14.95+2PH  
Now, with only a couple of keys, you can design your own sound effects on the QL and print out the SuperBasic line as it will appear in the program!  
A great SuperBasic programming tool!

**BEST SELLERS!**

- RMG#294 ADVANCED 2068 MACHINE CODE PROGRAMMING--ONLY \$ 16.95+3PH  
The 3rd in Dr. Dregers' great series of books on 2068 machine code programming. A must for any SERIOUS 2068 programmer!
- RMG#345 ARROW-SOUNDESIGN--(S/W)(2068)-----ONLY \$ 14.95+2PH  
Here is the original sound designing program for the 2068. Use only 3 keys! Learn how to use the 3 channels available to you!
- RMG#127 1987 NW MINI-FAIR SEMINAR VIDEO TAPE----ONLY \$ 15.95PP  
Find out what the speakers at this gathering had to offer. Every computer buff will learn something from at least one of these! (6 hours)

**RMG ENTERPRISES**

MASTERCARD

1419 1/2 7TH STREET  
OREGON CITY, OR 97045

VISA

VOICE 503/655-7484(10AM-10PM PT) \* BBS 503/656-8072(8PM-10AM PT)

\*\*\*\*\*

For BIG 55 page catalog-send \$3.00 (Refunded first order)

\*\*\*\*\*



# MANDELBROT -- A Fractal World Part Two

Michael E. Carver

## The BASICS

I hope you have been experiencing great adventures exploring the new frontiers opened up by fractal geometry. In this part of the article we will examine the BASIC program.

For those of you who are learning the ropes of SuperBASIC, I will point out some of the highlights of the BASIC Mandelbrot program featured in the previous issue of Time Designs (Nov/Dec 1987 pp 23-28). It was my intent to write a program using the power and flexibility of SuperBASIC. To demonstrate the power of SuperBASIC, the major portion of the BASIC program is comprised of only 2 lines (lines 60 & 70). The rest of the program is solely support procedures for these two lines of BASIC. The program contains 18 procedure modules and 1 function module. Advantages of writing programs in this manner include the ease of extending and following the program when it comes time to de-bug.

Our first procedure is *initial*, which sets up the computer to run the program. Line 2550 declares the variables *x*, *y* & *i* to apply only to the PROCEDURE *initial*. If these variable names are used elsewhere in the program, the values set in the PROCEDURE will not apply. By using the SuperBASIC command LOCAL, one does not have to worry about re-declaring a variable which is needed elsewhere in the program. However one must be careful when using this command. If the PROCEDURE is called again and the value of a LOCAL variable is to be used with the contents when the PROCEDURE was exited, the original value is lost. From within the *initial* PROCEDURE, another PROCEDURE (*tv*) is called, which simply redefines the default windows to fit within a U.S. TV screen and sets the MODE to 8 colors. The rest of the *initial* PROCEDURE "draws" the title screen, loads the 3 machine code routines into memory, defines and POKES into the "plotter"

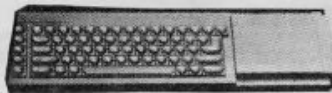

fig. 1

### PROCEDURE and FuNction list

PROCEDURE	Line Nos.
back_door	1080-1190
canvas	4640-4670
check_dev	1690-1840
color-bar	4280-4330
done	1210-1360
initial	2540-2850
main_menu	1930-2310
main_prog	1000-1060
mini_menu	2330-2520
mini_window	1860-1910
paste	4490-4510
re_color	3740-4260
recall	3150-3490
redraw	3510-3720
set_up	2870-3130
snap_shot	4450-4470
store_it	1380-1670
tv	4530-4620
FuNction	
keyini	4350-4430

machine code routine the default color schemes for the Mandel set, and sets up the default device and name for saving result data.

PROCEDURE *main\_prog* is the work-horse of the program. It consists of an endless loop which controls the branching of the program. This was achieved by not providing an exit to REPEAT *bigloop*.

*Main\_menu* is the PROCEDURE which prints the menu and redirects the program based on the user's input. The "shadows" in the fractal are created by using the STRIP and CURSOR commands. By offsetting the cursor location 4 pixels and setting the color, a shadow is drawn and then the text is written over the shadow (see lines 1960-2070). The REPEAT *response* loop reads the keyboard for correct input and branches accordingly. Line 2240 calls the FuNction *keyini* which translates any key pressed into its ASCII code and returns the result in variable *a* and is passed to the variable *key* (see line 4410). Lines 2240-2300 return this PROCEDURE to an appropriate PROCEDURE based on what branch were made due to user input. Line 2280 allows a PROCEDURE to be re-entered if the value of *key* was changed to 100 (see line 2280 of PROCEDURE *redraw*).

The *set\_up* PROCEDURE provides a means for directing the setup for a particular part of the fractal world and for the changing of default device and data name. A machine code routine which sets up machine code variables for a fresh start is also called from within this PROCEDURE. (NOTE: This PROCEDURE has one major weak link, no checks are made for correct user input. If user inputs blank lines or letters instead of numbers, the program will crash. Those of you who are industrious may wish to write a couple of "Check" PROCEDURES to insure proper input.)

To insure the flow of the program, the *back\_door* PROCEDURE provides a "Sub-Routine" which steps through the creation of the Fractal data and screen. When this PROCEDURE is exited by "falling-out" through the end (line 1190), the program continues from the branch created within *main\_prog*, continuing with a call of the PROCEDURE *store\_it*. After a complete fractal map has been created, a prompt will appear on the screen prompting the user to ready the device for the saving of data (see lines 1182 & 1184) and for a key press to continue (see line 1186). (NOTE: To insure that the messages printed in the "mini\_window" can be seen (includes the above prompt and "mini\_menu"), the computer must be initialized in TV Mode (Due to the difference in line spacing between Monitor and Monitor Mode.)

The *mini\_window* PROCEDURE calls a machine code routine which makes a copy of screen data in the area to be overwritten by a new window opened by line 1890. This data is restored by a machine code routine called by the *paste* PROCEDURE. Note: Correction to a cosmetic error in listing 1 -- Line 4510 should read "END DEFINE paste". This correction is only for consistency as the program will run fine as written.

Before data is saved to microdrive (or specified device), a check is made by the *store\_it* PROCEDURE to insure that an error report is not generated if files already exist with the same name. This is accomplished by lines 1390-1540 and the PROCEDURE *check\_it*. If files of the same name do exist, the user is allowed to re-enter the data to be saved or allow the existing files to be deleted from the medium before a save is executed.

The last major PROCEDURE left is *re\_color* which allows the user to redefine the color scheme for the points within and outside the Mandelbrot set. There are a total of 255 different possible calculated "distance" points. If they have not yet been arranged into a table of dispersion, this calculation is carried out by lines 3770-3930. The resulting calculations will provide a rough guide to help in re-defining the color scheme. Lines 4060-4080 will build up a new color scheme based on the user's input.

The remainder of the PROCEDURES should be easy to decipher based on the above information and by following their logical flow. I hope that by following the program carefully and by experimenting with the various SuperBASIC commands included within the program that readers who are striving to learn the power of the SuperBASIC programming language will have a head start.



## QL Sound Explorer

M. Vincent Lyon

### Q\_LINK

THE ULTIMATE TERMINAL FOR THE QL

AUTODIAL, REDIAL INTEGRAL EDITOR  
 XMODEM CHECKSUM, XMODEM CRC  
 & ASCII FILE TRANSFER  
 ZOOM PRINTING FOR SPEED  
 SUPPORTS XON/XOFF HANDSHAKING  
 DIRECTORY WITH FILE LENGTH, TYPE  
 CONFIGURATION FILE STORES UP TO 40  
 TELEPHONE NUMBERS, 20 SIGNONS.  
 EDIT BBS NAMES, NUMBERS & SIGNONS  
 PAINLESSLY TO CREATE CONFIG. FILE  
 MENU/QUICK MODES FOR NOVICE/EXPERT  
 USE WITH ANY MODEM, 8 COMMANDS  
 SUPPORTS ALL QL BAUDRATES  
 100% MACHINE LANGUAGE FOR SPEED  
 COMPATIBLE WITH JSU, JM ROMS  
 REQUIRES MONITOR. COMES WITH THREE  
 UTILITIES INCL. UNSQUEEZE, LIBRARY

US\$ 19.95 + \$2.00 shipping  
 Supplied on MDV or 5.25" disk  
 [specify tpi]

Meta Media Productions  
 726 WEST 17TH VANCOUVER, BC  
 CANADA V5Z 1T9

With eight different variables to modify and test, the BEEP command on the Sinclair QL can be a bit difficult to master. When I needed some special sounds for a game I was writing, it became obvious that typing in a long list of BEEP commands for testing was a long and tedious job. So, I stopped writing the program long enough to design a special program that would allow me to explore the full range of the QL sound capabilities.

Thus was QL SOUND EXPLORER born. Besides being an easy method of designing and testing various sounds, it also turned out to be fun.

The program uses two types of input keys, called only by pressing the proper key (the ENTER key need never be pressed). The command keys call various program commands, and the variable control keys control each of the eight QL BEEP variables.

Once the program is booted (it tells you by "sounding off"), use the variable control keys (1 to 8) to set the BEEP values you desire, and press "t" to test the result. The lower window will, in the test mode, display the correct SuperBASIC line for entry into your program. Pressing "P" will send this line to your printer.

Any of the included demos can be used as starting points for your own sounds if you wish. Or, if you wish to start fresh, simply press "c" to clear all the variables and refresh the memory.

If you don't arrive at the perfect sound the first time, just press "b" to turn off the sound (if your QL is still "sounding off"), and modify your variables.

As soon as you discover the proper formula for the sound you desire, print out or write down the SuperBASIC line for future reference. Trying





to arrive at exactly the same sound later is not as easy as it may appear.

Remember that the ESC (escape) key is valid. Pressing it will exit the program, though you may not be able to see the cursor. If you unintentionally press ESC or break the program, simply enter "GO TO 10".

If you don't wish to type in this listing, the program is available from: RMG Enterprises, 1419 1/2 7th St., Oregon City, OR 97045.

The Command Keys...

M - Displays the remaining memory	C - Clears the Variables/Refreshes memory
P - Prints the Basic Command line	T - Tests the current BEEP values
B - Turns off the current test	A - Plays Demo "engine idle"
S - Plays Demo "engine rev"	D - Plays Demo "arcade sounds"
F - Plays Demo "QL jig"	G - Plays Demo "phasor fire"
H - Plays Demo "stalking spook"	J - Plays Demo "British police"
K - Plays Demo "frightened heart"	L - Plays Demo "unknown melody"

The Variable Control Keys...

1 - Controls DURATION : 1 = up by 10. CTRL/1 = up by 100. SHIFT/1 = down by 100. CTRL/SHIFT/1 = down by 100.

2 - Controls PITCH 1 : 2 = up by 1. SHIFT/2 = down by 1

3 - Controls PITCH 2 : 3 = up by 1. SHIFT/3 = down by 1.

4 - Controls GRAD\_X : 4 = up by 10. CTRL/4 = up by 100. SHIFT/4 = down by 10. CTRL/SHIFT/4 = down by 100.

5 - Controls GRAD\_Y : 5 = up by 1. SHIFT/5 = down by 1.

6 - Controls WRAP : 6 = up by 1. SHIFT/6 = down by 1.

7 - Controls FUZZY : 7 = up by 1. SHIFT/7 = down by 1.

8 - Controls RANDOM : 8 = up by 1. SHIFT/8 = down by 1.

```

10 LET p2=0:LET p3=1:LET p4=29:LET
p5=1000
15 LET p6=3:LET p7=0:LET p8=0:LET p
9=0
20 init
25 disp
30 key
35 GO TO 30
40 DEFine PROCedure key
45 LET k=CODE(INKEY#(-1))
50 read_key
55 GO TO 30
60 END DEFine
65 DEFine PROCedure init
70 LET a=6
75 WINDOW #1,512,204,0,0
80 PAPER #1,0:INK #1,7
85 BORDER #1,2,7,2:CLS #1
90 WINDOW #0,512,50,0,205
95 PAPER #0,5,7:INK #0,0
100 BORDER #0,3,0,5:CLS #0
105 PRINT #0,\,,," ";
110 PAPER #0,5:PRINT #0;" > EXECUTI
VE SOUND EXPLORER < ":PAPER #0,5,7
115 PRINT #0,\,,,"COPYRIGHT 1987 - EX
ECUTIVE WORKSHOP - PORTLAND, OREGON
":PRINT \,,," ";
120 PAPER #1,5,7:INK #1,0:PRINT">>>
> CURRENT QL BEEP VALUES <<<<":PAPE
R #1,0:INK #1,7
125 PRINT \,,,"1-DURATION",\,,,"2-PI
TCH"
130 PRINT \,,,"3-PITCH 2",\,,,"4-GRAD
_X"
135 PRINT \,,,"5-GRAD_Y",\,,,"6-WRAP"
140 PRINT\,,,"7-FUZZY",\,,,\,,,"8-RANDOM
"
145 WINDOW #2,45,12,118,60
150 PAPER #2,0:INK #2,7
155 BORDER #2,1,5:CLS #2
160 OPEN #3,con
165 WINDOW #3,45,12,345,60
170 PAPER #3,0:INK #3,7
175 BORDER #3,1,5:CLS#3
180 OPEN #4,con
185 WINDOW #4,45,12,118,90

```

```

190 PAPER #4,0:INK #4,7
195 BORDER #4,1,5:CLS #4
200 OPEN #5,con
205 WINDOW #5,45,12,345,90
210 PAPER #5,0:INK #5,7
215 BORDER #5,1,5:CLS #5
220 OPEN #6,con
225 WINDOW #6,45,12,118,120
230 PAPER #6,0:INK #6,7
235 BORDER #6,1,5:CLS #6
240 OPEN #7,con
245 WINDOW #7,45,12,345,120
250 PAPER #7,0:INK #7,7
255 BORDER #7,1,5:CLS #7
260 OPEN #8,con
265 WINDOW #8,45,12,118,150
270 PAPER #8,0:INK #8,7
275 BORDER #8,1,5:CLS #8
280 OPEN #9,con
285 WINDOW #9,45,12,345,150
290 PAPER #9,0:INK #9,7
295 BORDER #9,1,5:CLS #9
300 PRINT \," BASIC LINE TO READ:
BEEP "
305 OPEN #10,con
310 WINDOW #10,340,12,162,180
315 PAPER #10,0:INK #10,7
320 BORDER #10,1,2:CLS #10
325 BEEP p2,p3,p4,p5,p6,p7,p8,p9
330 PAUSE 150
335 BEEP
340 END DEFine
345 DEFine PROCedure t
350 disp
355 BEEP p2,p3,p4,p5,p6,p7,p8,p9
360 key
365 END DEFine
370 DEFine PROCedure b
375 BEEP
380 key
385 END DEFine
390 DEFine PROCedure read_key
395 SELECT ON k
400 =116:t
405 =112:up_d:prt
410 =99:cler
415 =106:d7
420 =104:d6
425 =97:d1
430 =115:d2

```

```

435 =100:d3
440 =102:d4
445 =103:d5
450 =107:d8
455 =108:d9
460 =109:mem
465 =98:b
470 =49:CLS#2:IF p2<32757:LET p2=p2
+10:END IF :LET p2#=p2:AT #2,0,a-(L
EN(p2#)):PRINT #2;p2#:key
475 =33:CLS#2:IF p2>-32757:LET p2=p
2-10:END IF :LET p2#=p2:AT #2,0,a-(
LEN(p2#)):PRINT #2;p2#:key
480 =145:CLS#2:IF p2<32667:LET p2=p
2+100:END IF :LET p2#=p2:AT #2,0,a-
(LEN(p2#)):PRINT #2;p2#:key
485 =129:CLS#2:IF p2>-32667:LET p2=
p2-100:END IF :LET p2#=p2:AT #2,0,a
-(LEN(p2#)):PRINT #2;p2#:key
490 =50:CLS#3:IF p3<255:LET p3=p3+1
:END IF :LET p3#=p3:AT #3,0,a-(LEN(
p3#)):PRINT #3;p3#:key
495 =64:CLS#3:IF p3>0:LET p3=p3-1:E
ND IF :LET p3#=p3:AT #3,0,a-(LEN(p3
#)):PRINT #3;p3#:key
500 =51:CLS#4:IF p4<255:LET p4=p4+1
:END IF :LET p4#=p4:AT #4,0,a-(LEN(
p4#)):PRINT #4;p4#:key
505 =35:CLS#4:IF p4>0:LET p4=p4-1:E
ND IF :LET p4#=p4:AT #4,0,a-(LEN(p4
#)):PRINT #4;p4#:key
510 =52:CLS#5:IF p5<32757:LET p5=p5
+10:END IF :LET p5#=p5:AT #5,0,a-(L
EN(p5#)):PRINT #5;p5#:key
515 =36:CLS#5:IF p5>-32758:LET p5=p
5-100:END IF :LET p5#=p5:AT #5,0,a-
(LEN(p5#)):PRINT #5;p5#:key
520 =148:CLS#5:IF p5<32657:LET p5=p
5+100:END IF :LET p5#=p5:AT #5,0,a-
(LEN(p5#)):PRINT #5;p5#:key
525 =132:CLS #5:IF p5>-32657:LET p5
=p5-100:END IF :LET p5#=p5:AT #5,0,
a-(LEN(p5#)):PRINT #5;p5#:key
530 =53:CLS#6:IF p6<7:LET p6=p6+1:E
ND IF :LET p6#=p6:AT #6,0,a-(LEN(p6
#)):PRINT #6;p6#:key
535 =37:CLS#6:IF p6>-8:LET p6=p6-1:
END IF :LET p6#=p6:AT #6,0,a-(LEN(p
6#)):PRINT #6;p6#:key

```

```

540 =54:CLS#7:IF p7<15:LET p7=p7+1:
END IF :LET p7%=p7:AT #7,0,a-(LEN(p
7%)):PRINT #7;p7%:key
545 =94:CLS#7:IF p7>0:LET p7=p7-1:E
ND IF :LET p7%=p7:AT #7,0,a-(LEN(p7
%)):PRINT #7;p7%:key
550 =55:CLS#8:IF p8<15:LET p8=p8+1:
END IF :LET p8%=p8:AT #8,0,a-(LEN(p
8%)):PRINT #8;p8%:key
555 =38:CLS#8:IF p8>0:LET p8=p8-1:E
ND IF :LET p8%=p8:AT #8,0,a-(LEN(p8
%)):PRINT #8;p8%:key
560 =56:CLS#9:IF p9<15:LET p9=p9+1:
END IF :LET p9%=p9:AT #9,0,a-(LEN(p
9%)):PRINT #9;p9%:key
565 =42:CLS#9:IF p9>0:LET p9=p9-1:E
ND IF :LET p9%=p9:AT #9,0,a-(LEN(p9
%)):PRINT #9;p9%:key
570 =27:finish
575 =REMAINDER :key
580 END SELEct
585 DEFine PROCedure finish
590 STOP
595 END DEFine
600 DEFine PROCedure mem
605 CLS#10:INK #10,5:PRINT #10;" -
- AVAILABLE MEMORY - ";PEEK_L(1638
56)-PEEK_L(163852);" ---":INK #10,7
610 key
615 END DEFine
620 DEFine PROCedure disp
625 LET p2%=p2
630 CLS#2:AT #2,0,a-(LEN(p2%)):PRIN
T #2;p2%
635 LET p3%=p3
640 CLS#3:AT #3,0,a-(LEN(p3%)):PRIN
T #3;p3%
645 LET p4%=p4
650 CLS#4:AT #4,0,a-(LEN(p4%)):PRIN
T #4;p4%
655 LET p5%=p5
660 CLS#5:AT #5,0,a-(LEN (p5%)):PRI
NT #5;p5%
665 LET p6%=p6
670 CLS#6:AT #6,0,a-(LEN(p6%)):PRIN
T #6;p6%
675 LET p7%=p7
680 CLS#7:AT #7,0,a-(LEN(p7%)):PRIN
T #7;p7%
685 LET p8%=p8
690 CLS#8:AT #8,0,a-(LEN(p8%)):PRIN
T #8;p8%
695 LET p9%=p9
700 CLS#9:AT #9,0,a-(LEN(p9%)):PRIN
T #9;p9%
705 up_d
710 END DEFine
715 DEFine PROCedure d1
720 LET p2=0:letp3=0:LET p4=0:LET p
5=0
725 LET p6=3:LET p7=0:LET p8=15:LET
p9=0
730 up_d:t
735 key
740 END DEFine
745 DEFine PROCedure d2
750 LET p2=0:LET p3=255:LET p4=125:
LET p5=1300
755 LET p6=0:LET p7=0:LET p8=0:LET
p9=0
760 up_d:t
765 key
770 END DEFine
775 DEFine PROCedure d3
780 LET p2=0:LET p3=255:LET p4=10:L
ET p5=700
785 LET p6=2:LET p7=8:LET p8=0:LET
p9=0
790 up_d:t
795 key
800 END DEFine
805 DEFine PROCedure d4
810 LET p2=0:LET p3=255:LET p4=5:LE
T p5=3000
815 LET p6=2:LET p7=5:LET p8=0:LET
p9=0
820 up_d:t
825 key
830 END DEFine
835 DEFine PROCedure d5
840 LET p2=0:LET p3=0:LET p4=75:LET
p5=200
845 LET p6=1:LET p7=10:LET p8=0:LET
p9=0
850 up_d:t
855 key
860 END DEFine
865 DEFine PROCedure d6
870 LET p2=0:LET p3=175:LET p4=80:L
ET p5=10000
875 LET p6=3:LET p7=3:LET p8=0:LET
p9=0
880 up_d:t
885 key
890 END DEFine
895 DEFine PROCedure d7
900 LET p2=0:LET p3=3:LET p4=0:LET
p5=7500
905 LET p6=6:LET p7=0:LET p8=0:LET
p9=0
910 up_d:t
915 key
920 END DEFine
925 DEFine PROCedure dB
930 LET p2=0:LET p3=255:LET p4=250:
LET p5=0
935 LET p6=7:LET p7=1:LET p8=2:LET
p9=0
940 up_d:t
945 key
950 END DEFine
955 DEFine PROCedure d9
960 LET p2=0:LET p3=36:LET p4=53:LE
T p5=2500
965 LET p6=7:LET p7=4:LET p8=0:LET
p9=0
970 up_d:t
975 key
980 END DEFine
985 DEFine PROCedure cler
990 CLEAR
995 LET a=6
1000 LET p2=0:LET p3=0:LET p4=0:LET
p5=0
1005 LET p6=0:LET p7=0:LET p8=0:LET
p9=0
1010 LET p2%=p2:LET p3%=p3:LET p4%=
p4:LET p5%=p5
1015 LET p6%=p6:LET p7%=p7:LET p8%=
p8:LET p9%=p9
1020 INK #10,2:PRINT #10;" -- VAR
IABLES CLEARED ---":INK #10,7
1025 BEEP 0,3,1,550,0,0,0,0
1030 PAUSE 45
1035 BEEP
1040 disp
1045 key
1050 END DEFine
1055 DEFine PROCedure up_d
1060 LET p2%=p2:LET p3%=p3:LET p4%=
p4:LET p5%=p5
1065 LET p6%=p6:LET p7%=p7:LET p8%=
p8:LET p9%=p9
1070 LET pf%="p2%&","&p3%&","&p4%&","
&p5%&","&p6%&","&p7%&","&p8%&","&p
9%
1075 CLS#10:PRINT #10,pf%
1080 END DEFine
1085 DEFine PROCedure prt
1090 OPEN #11,ser
1095 PRINT #11,"SuperBASIC line to
read - BEEP ";pf%
1100 CLOSE #11
1105 key
1110 END DEFine

```

## \*\*\*\*\* Time Designs Tests \*\*\*\*\*

### QUANTA, the Library, and PAGE DESIGNER

by

Mike de Sosa

My apologies again! I still have not seen *DESKTOP PUBLISHER Special Edition*--so much for the Great Facilitator! But after you see what *PAGE DESIGNER* does for you--and what it costs--you might well think, "Who needs *DESKTOP PUBLISHER*, anyway?"

*QUANTA* is the acronym of the independent *QL Users and Tinkerers Association*, a UK-based users' group. *QUANTA* has for several years published an excellent monthly newsletter (about 40 5"x7" pages),

and membership is by subscription to the newsletter. (There are several subscription options, e.g., AIRMAIL delivery, and with the dollar free-falling as it is, I recommend you contact *QUANTA's* secretary, Brian Pain [see his address in the illustration], for details of membership.

*QUANTA* also offers free advice to members, workshops, support for users' groups, tutors, and most importantly, a now massive--and rapidly growing--software



library consisting of more than 350 suites of performance-tested programs of all types --and I mean all types--most available at cost, a few at a small cost. The royalty for PAGE DESIGNER, the most expensive QUANTA program, is only £5, less than \$10, today; royalties for the entire library, consisting of about 20 quad-density floppy disks and including a sophisticated run-time ARCHIVE library guide (updated at 6-month intervals), are now about £35, about \$63.

It's only a wag, but I'd say that the documentation for the complete QUANTA library, must run to more than 500 pages. I can think of no better way of learning good QL programming technique, than looking into the library programs, although more and more of them are being re-issued in compiled versions. Digging into the QUANTA library is a never-ending task like excavating tombs in the Middle East and cataloging and cross-referencing your findings.

QUANTA, the monthly newsletter, is also a goldmine of tips; useful programs, procedures, and functions; reviews of new software by members (that is, not by magazine writers who are sometimes biased in favor of advertisers); and solutions to practical programs.

#### QUANTA's PAGE DESIGNER \* \* \* \* 1/2

Dilwyn Jones's excellent desktop-publishing program enables the user to create small, page-sized, or large (about 17"x 22") pages of mixed text and graphics for various types of layouts and purposes. Fast, easy-to-use, and efficient--utilizing screen and memory compression whenever possible, PAGE DESIGNER requires at least 256K of extra RAM and more is better (it is terrific with TRUMP CARD with which a large-capacity or dynamic RAM disk may be used to good effect for more rapid cutting and pasting--just format a RAM disk in the boot program). Two excellent font editors are included, one for normal text (the standard QDOS 9- x 5-pixel type) and one for self-scaling and proportionally printed high-resolution (16- x 16-pixel) text or graphics. Used for different purposes, the former for normal text, the latter for larger, self-scaled text, PAGE DESIGNER includes 29 text fonts and 17 high-resolution fonts.

On boot-up, the first PAGE DESIGNER task is to size the page, simplicity itself, with elaborate mini-screens to keep you in touch with just where you are on the page. After this, the Main Menu is displayed. Options offered are (1) Enlarged Characters (which initiates a sequence to incorporate high-resolution, usually large-sized, and self-scaled printing; (2) Type Text which initiates more normal text-printing; (3) Merge Text which lets you import text (i.e., ASCII text files [e.g., QL QUILL \_lis files]) into regular or columnar format--see HOT TIP, below; (4) PAGE POSITION which displays where you are on the larger page; (5) Graphics which opens the door to several graphics sub-menus; (6) Save Page in compressed memory form; (7) Load New Page; (8) Wipe/New Page; (9) Printout to printer or file; (A) Load Alphabets (text and/or high-resolution fonts); (Q) Quit [ESC also

works]; (V) View Page which permits scanning and positioning the art window on any section of the larger page; (D) List of Files Present provides a directory of any device; (R) Refresh Display is intended for use in multitasking situations; (L) Lift and Save enables cutting and pasting via a file (optimally a RAM disk file); (P) Load and Paste enables continuation of the cut-and-paste process or the inclusion of previously saved graphic segments (illustrations, etc.); (O) Set OVER State selects one of three modes of printing; (S) Set Stipple Pattern permits several monochromatic INK and PAPER options; (F) Status Report portrays useful data such as PAPER and INK colors, OVER state, free memory, page size and position, and free memory required to fill page; and (E) Erase Files which is used primarily to keep free memory as large as is necessary.

Selecting "G" or "g" for Graphics takes you to the Graphics Menu which offers the following options (here menu selection is made with the CURSOR, SPACE, and ENTER keys): Move Cursor permits movement of the graphics cursor, a "+" sign, without inking the art window; Dots, Lines, Arcs, Rectangle, Circle/Polygon, Ellipse, and Triangle permits the sizing and placing of such figures on the page; Sketch permits "Etch-a-Sketch" type free-hand drawing with the CURSOR and SHIFT CURSOR keys; Paint permits the solid-color filling of irregularly shaped, enclosed spaces; Fancy Fills initiates a fill sequence from another graphics sub-menu offering 15 patterns and varying degrees of detail; Brush Lines initiates a variable width brush sequence using selected monochromatic ink colors and is also used to erase unwanted page sections; Colours selects INK and PAPER monochromatic stippling; Set Over sets the OVER state as in SuperBASIC; and Page Position which displays the position of the artwork window on the page.

As may be seen, operation of PAGE DESIGNER is both straightforward and fairly efficient. I withheld the ultimate 1/2 star (\*) for two reasons: cutting and pasting and the incorporation of text files into columnar format could be made a bit more simple--as I am sure they will be in a future version of PAGE DESIGNER which, who knows, may be on the very next floppy disk I receive from the library.

FRONT PAGE EXTRA is a little better in a few respects, and Digital Precision's DESKTOP PUBLISHER Special Edition may well be superior, but I'll have to see it to believe it. And don't forget, you can probably get a year's subscription to QUANTA and the entire QUANTA Library of programs for about the same price as DESKTOP Publisher Special Edition! There can be no doubt as to the relative value received for money of the two options.

HOT TIP: Format your QL QUILL document into a 32-column wide format before PRINTING to a "\_lis" file for import into PAGE DESIGNER for two columns on a standard page.

NEXT TIME: Who knows? Perhaps DESKTOP PUBLISHER Special Edition, the CPMulator, SpeedScreen, Microbridge, or a new better-than-QUILL word processor. It is all up to the Great Facilitator.

# PAGE DESIGNER 2 FONTS LIST EXAMPLE PAGE

TEXTFONTS:1=Normal 2=Square 3=Small 4=Bold 5=Alien 6=Italics 7=Zipper  
 8=Bottleneck 9=DATA70 10=Countdown 11=ARCADÉ 12=Fancy beersever 13=81 14=9e Oldé  
 15=HALF HEIGHT 16=traffie 17=Extra-bold 18=Futura-display 19=Futura-black  
 20=0din 21&22:see side 23=000line 24=Heavy 25=3ABVLETH 26=RURA SCRIPY  
 27=STENCIL unop-episdq=8Z 29=Sans-serif HIRESFONTS:1=Blank 2=Normal 3=Bold  
 4=Italics 5=Bold italics 6=Bold text+graphics 7=000line 8=Sci-Fi 9=STENCIL  
 10=DATA70 11=Countdown 12=HEADLINE 13=Futura-display 14=LCD 15=ZIPPER  
 16=OCR-9 17=Bold-sans-serif

TEXTFONTS 1 - UP  
TEXTFONTS 2 - DOWN

This page shows the currently available fonts for Page Designer. (if you have any suggestions for any more, i would be pleased to hear from you. HOPE THEY ARE OF USE TO YOU! PAGE AND NEW FONTS (C) 1987 DILWYN JONES

## Page Designer

PAGE DESIGNER's demo page, displaying its 29 Text fonts and 17 High-res. fonts, is shown above. PAGE DESIGNER's graphic capabilities are equally as comprehensive and easy to use.

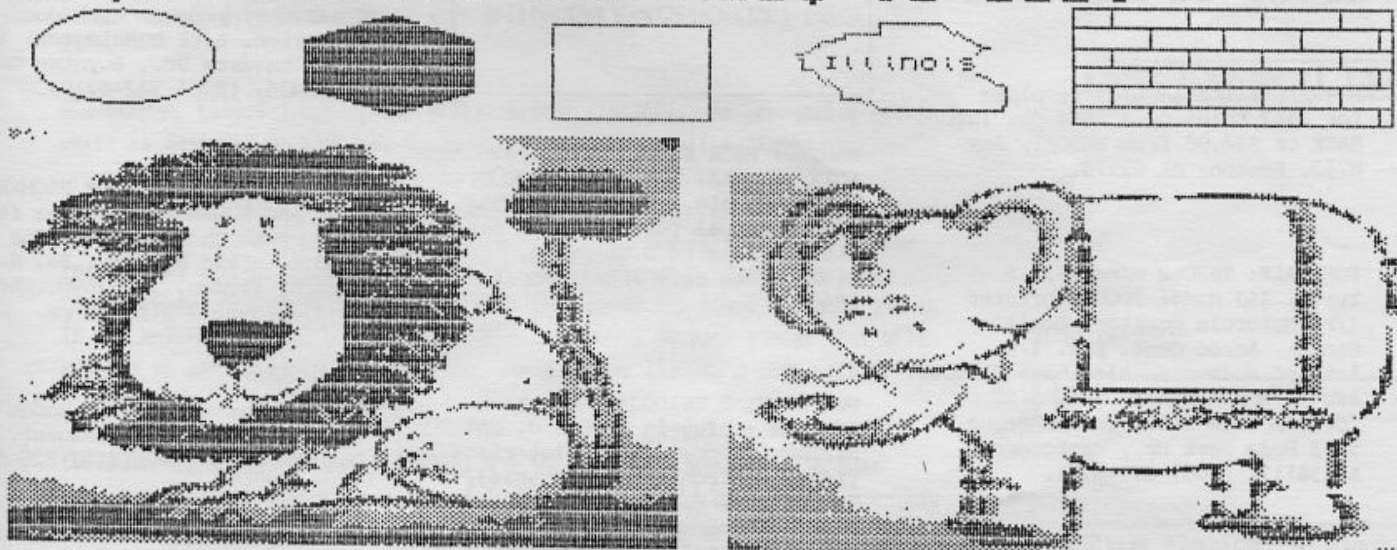

PAGE DESIGNER is just one of more than 300 programs available at little or no cost from QUANTA's (QL Users and Tinkerers Association) library. QUANTA (a British society) also provides an excellent monthly newsletter. Write or call (evenings only between 7pm and 10pm London time) Brian Pain, 24 Oxford Street, Stone Stratford, Milton Keynes MK11 1JU, United Kingdom (telephone [0908] 564271) regarding membership options.

### USING THE PICTURE LIFT FILES

Dilwyn Jones, 4 The Crescent, Bangor, Gwynedd, North Wales, LL57 2AA, United Kingdom. Telephone: Bangor (0248) 354023.

These files can simply be imported directly into Page Designer V1.33 and later versions of that program. Earlier versions have not been tested, but as there are no known copies in circulation, this should not be a problem. From the main menu, select the LOAD AND PASTE option and enter the filename of the picture you want, e.g. "mdv1\_JUMBO\_lift". All names on the cartridge end in "\_lift" for clarity, but they can of course be changed to suit your requirements. Best of luck and remember to let me know of any suggestions/criticisms/requirements so that I can add to this library of pictures for Page Designer 1.



Order my new book, TAKING THE QUANTUM LEAP, from Time Designs today. Mike de Sosa



T & C SERVICES  
20 LIBERTY TERRACE  
BUFFALO, N.Y. 14215

716-834-1716

Call or Write for a free catalog of  
products for the Timex Computers.

# the CLASSIFIED

FREE ADS FOR SUBSCRIBERS

FOR SALE: TAX-I-QL/87 template  
for 1987 taxes on a 256K QL. Info  
SASE or \$24.95 from EMSOFT, Box  
8763, Boston, MA 02114.

FOR SALE: TS2068 w/manual, 5  
texts, A&J Model 2000 w/printer  
I/F, Motorola monitor, Gorilla  
Banana, Aerco Cent. par. I/F,  
lots of software. Also have TS1000  
and TI 99/4A w/Acc. Send SASE  
for complete list. Tom McHargue,  
5713 Hyde Park Dr., Montgomery,  
AL 36117, (205) 277-0271.

TS2068 OWNERS: Greenville, SC  
area...FREE- my serious, and  
original programs & animations.  
Call me: (803) 297-0502, to view  
and tape. Howard Wilkerson, 313  
Providence Square, Greenville,  
SC 29615.

\*\*\* CLOSE-OUT SALE \*\*\*

TS2068 SOFTWARE

"DIAMOND MIKE"

"GREAT GAMES AND GRAPHICS SHOW"

Each originally sold for \$24.95, but get  
both for just \$9.95—while supplies last.

"INTEGER BASIC COMPILER"

"Z80 ASSEMBLER"

Both for \$9.95 (while supplies last).  
Includes 19 pages of documentation

JRC SOFTWARE

200 N. Main St.  
Scottsburg, IN 47170  
(812) 752-6071

HOME COMPUTER REPAIRS

Write For Prices.

Dan Elliott

Rt 1 Box 117

Cabool, MO 65689

(314) 739-1712

WANTED: BACK ISSUES T/S Mags.  
(QZX, SYNTAX, TDM, SUM, SINCUS,  
T/S USER, etc.) also; schematic,  
owners manual for T/S 1500. Send  
list, prices to D.G. Smith,  
R.415 Stone St., Johnstown, PA  
15906.

FOR SALE: 2 TS1000's, Memotech  
64K RAM + plug-in keyboard, CAI  
Stringy Floppy drive w/interface  
(incl. Centronics I/F w/cable),  
TS 16K RAM, books, software and  
misc. cables, parts, etc. \$200.  
Lionel Barthelemy, 11009 Vivian Dr.,  
Huntsville, AL 35810, (205) 859-  
2944.

MILLENNIA-K USERS: Accts. Rec.  
2068, 64 Col. Small Business  
Revolving Charge Account Manager.  
1,100 Accounts per disk, 24 entry  
lines each. SPDOS 5 1/4" Quad Disk  
\$20.00 ppd. Jim Bretz, 861 5th  
Ave SW, Perham, MN 56573, (218)  
346-2129, 6-10 pm.

WANTED: Copies of old ZX81 ROM  
disassembly by Logan, and  
"Mastering M.C." by Baker. Will  
buy or trade for ZX81, 2068 or  
QL items. (For a list, send  
S.A.S.E.). Paul Bingham, PO Box  
2034, Mesa, AZ 85214.

HARDBACK SOFTWARE! 17 TITLES.  
AERCO PRINTER CABLE & PROGRAM,  
FLIGHT CARTRIDGE, MODEM PROGRAM,  
MISC. 2068 CASSETTES, ORIGINAL  
MATERIAL; ALL 30% BELOW RETAIL.  
FREE SHIPPING. PH# 1-512-839-4516.

WANTED: Z-99 COMPILER, Kopak  
Creations, program with docu-  
mentation. Earl Dunnington, 4356  
King Theodore Dr., Boynton Beach,  
FL 33436, (305) 732-6219.

FOR SALE: MACHINE CODE PACMAN  
GAME and 9 NEW Font Styles for  
2068. Both on 1 cassette for \$10.  
Send to Steve Kershaw, 547 S.  
Church, Virden, IL 62690. Phone  
(217) 965-3537 after 5 pm.

WANTED: Westridge 2050 Modem for  
TS2068. Ed Ski, 4020 Regent,  
Duluth, MN 55804, (218) 525-5310.

TIME WARP Timex/Sinclair BBS at  
(515) 282-4169 (8/1/N) 300 baud,  
is open 24 hours/day. Over 400K  
of downloads (mostly 2068) with  
six message bases. The password  
is "GORT". Give it a call!

FOR SALE: 2 A&J Microdrives like  
new- 1 w/o print driver. \$90 & \$7.  
Also 34 m/wafers & caddy.  
R. Thompson, 34127 Williamsburg,  
Sterling Hgts, MI 48077, (313)  
977-0835.

WANTED: WAFAS for Rotronics  
Wafadrive (same as black wafas  
in A&J Mikrodrives). Used Wafas  
acceptable. Tony Brooks, 2951  
Pathview Lane, Marietta, GA 30062  
(404) 565-3879.

Do you have some equipment or a program that you would like to sell? Looking for something hard to find? Place an ad in **THE CLASSIFIEDS!** Subscribers can place one free personal ad in each issue. Ad size is 32 Col. wide (like 2040 paper) and maximum of six lines. For additional lines - \$3 each. **NON-SUBSCRIBERS** and **DEALERS:** \$4 a line. **DEADLINE FOR ALL CLASSIFIED ADS:** Two weeks before publication date. Mail your ad to:  
**TIME DESIGNS MAGAZINE, The Classifieds Dept., 29722 Hult Rd., Colton, Oregon 97017.**

# TIME SINCLAIR SOFTWARE

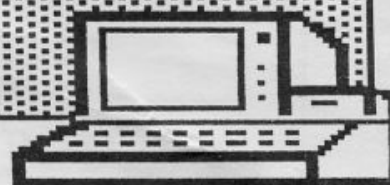

WMJ Data Systems  
4 Butterfly Drive  
Hauppauge, NY 11788  
(516)543-5252 11am-6pm EST M-F

ZX PRO/FILE (Prod# TS1PF) \$19.95 (TS1000). A machine language information storage and retrieval tool for 16-64K. Written by Thomas B. Woods. Multi-word search capability, instant file access, ordered displays, definable printer functions, totally flexible file size, 59 page tutorial manual. This is the finest data base program ever written for the TS1000/1500 and Sinclair ZX81.

ZX PRO/FILE

ACZ GENERAL LEDGER 1.000 (Prod# ACZ1) \$19.95 (TS1000). An accounting system which is designed to meet the accounting needs of a small business.

ACZ General Ledger

ACZ GENERAL LEDGER 2.000 (Prod# ACZ2) \$19.95 (TS2068). An accounting system designed for the small business. The ACZ 2.000 is flexibly designed so the reports fit your business whether it is a proprietorship, partnership or corporation. There's plenty of capacity with up to 150 named accounts and up to 800 entries and accounts each month. Includes a 20 page manual that will get you up and going in no time. For use with the TS2068, a 2040 printer is optional.

Colonize the Universe

COLONIZE THE UNIVERSE (Prod# TS2COL) \$16.95 (TS2068). Winning this game requires cunning, poise and a bit of luck. Try to build up your space colony in order to survive. Fuel and food are scarce and must be watched constantly in order to survive. Aliens, Black Holes, Super Nova Explosions and Time Warps are also abundant. This game is just like a galactic Monopoly game. It's great fun and provides hours of entertainment! We highly recommend this game!

The Dealer's Den

THE DEALER'S DEN (Prod# TS2DEN) \$16.95 (TS2068). If you love to play poker than this is the program for you. You play Draw Poker as you have seen in the arcade games at your local night club. You can also play four hands of Draw Poker against the dealer's one hand. Great Graphics make this software package a must for any computerist who loves Poker! Contains two programs: THE DEALER'S DEN and DRAW POKER.

PRO/FILE 2068

PRO/FILE 2068 (Prod# TS2PF) \$29.95 (TS2068). A professional file and database manager for the 2068. Instructions are displayed on the screen and guide you through the steps. After you have saved some files, you can access them by typing in any word, or group of numbers in that file. A 100+ page manual is included detailing the many uses - with instructions for use with a full size printer. The best data base system available for the TS2068. Just ask anyone who uses it.



Please include \$2.95 per order for shipping. NY residents add sales tax. Please mail your order to the above address. We accept checks, MasterCard, Visa and COD orders. A fee of \$1.90 will be added to COD orders. All in stock items will be shipped within 24 hours of receipt of order. Please use Prod# when ordering. Thanks for making us you T/S Software supplier!



ALSO AVAILABLE FOR THE T/S2

## POWERFUL AND INEXPENSIVE BUSINESS SOFTWARE FOR ZX81, T/S1000 and T/S1500 COMPUTERS

### ZX-TEXT



A word processor is to a computer user what a typewriter is to a typist, except that the former has more advantages than the latter. ZX-Text can operate in 16-64K RAM providing from 1300 to 6500 words per document. It features 6 different options: write, read, edit, print, save and clear text. Text is written on a per-line basis with quick speed and with horizontal back-space and delete capabilities being available. You can also access the editor directly from write mode and vice-versa. Text can be proof-read on a per-line basis allowing for enough time to determine if any editing is needed. The text editor allows a line of text to be deleted, inserted, replaced and listed for editing. You may also change a word or expression within a line, stop or start text while it is scrolling up the screen, begin reading text from the first line of the file, re-enter write mode from the editor, return to the main-menu or create a window so that you can read-edit two files simultaneously. The print option takes text displayed in 30-column format on the screen and outputs to either the ZX/TS printer. (With Memotech's Centronics Parallel Interface 80-column and lower/higher - case output is possible.) Files may be saved on tape cassette with the use of one single command, or by the same token they can be erased from memory / storage so that the full capacity of the program can be used for other purposes such as composing letters, reports, articles, memos, standard forms, instructions, ads, graphs, telephone directory, lists of customers, members, friends...etc. Also copies of files are always less expensive and easier to run than using a photocopier. Other advantages are savings in time, paper, ink, correcting mistakes and adding afterthoughts more efficiently than doing them through either handwriting or using a typewriter.

**\$16.95**

### ZX-CALC



An electronic spreadsheet calculator is the fundamental basic tool for summarising, reporting and analyzing in matrix form any accounting, mathematical or scientific manipulation of numbers. ZX-Calc operates in 32-64K RAM and affords a maximum of 3360 characters / spreadsheet. The entire matrix consists of 15 columns (letters A-O) and 30 rows (numbers 1-30) with 8 characters / cell. Unlike other popular ESCs, ZX-Calc uses in calculations and within cells all 14 math functions on the ZX-81/TS1000. It offers a unique \*SUM function that totals one or more rows/columns simultaneously. Parenthesis can be used within equations. There is no fixed limit on how many equations may be entered. Formulas may be stored in all 420 cells of the spreadsheet. The display affords 15 rows / columns. Loading of data into more than one cell can occur across / down one or more row / column simultaneously. With vertical windowing you can arrange a set of columns in any order, or practice using fixed-variable-alignment display formats. The menu offers 6 options: enter / erase, move, calculate, print, save and clear the spreadsheet. Enter / erase allows the entering, deletion or data alignment within a cell through the use of a mobile cursor. With the move option you may move around the entire spreadsheet to access any row, column or cell. The calculate option allows you to enter labels, values or formulas into a cell or write and enter equations that will act upon the data already within the spreadsheet. You can also enter bar graphs into a cell in this option. Absolute / relative replication, down / across a column / row, is also allowed by this option. Also this option allows the automatic calculation of the entire spreadsheet with one single command. Print allows you to output to either the ZX / TS printer the entire spreadsheet by column-sets and row-pages through use of the COPY command. The entire spreadsheet may be saved on cassette tape or you may clear all data from it or erase the program from RAM entirely. The most salient advantage provided by an ESC over specifically vertical applications software is that an ESC provides a reusable framework with which you can compose any specific financial model rather than just be limited to only one statically fixed format for storing, displaying and manipulating numerical data.

**\$16.95**

### ZX-CALENDAR

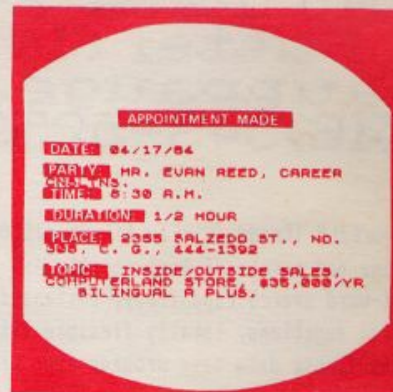

Time management is an important aspect of any serious business and personal agenda. Planning how to spend our time leaves us better prepared before and while we are spending it and we remain better organized after we finish spending it. ZX-Calendar operates in 16-64K RAM affording 25 appointments in 16K, 100 in 32K or 180 in 48K and 64K. Each appointment record holds a maximum of 220 characters. The main menu includes enter, search/check/sort, change, save, clear and print any and all appointments made on a specific date or with any party. Output to either the ZX/TS printer is permissible. This program will permit you to remember to do something or to be somewhere important by cataloging your answers to six questions that you must account for in order not to waste time when it is scarce: when, with whom, at what time, for how long, where and what are you going to discuss and conclude when you get together with someone else? The program lets you permanently originate, record, classify, search, sort, calculate, modify, summarize, obtain a written report and store your answers to the preceding questions so that you will not forget what you decide to do with your time. This program identifies your time according to when you are going to spend it and with whom you are going to share it. Through these forms of labeling appointments you are able to verify or modify how your time is budgeted without wasting ink, paper or more time trying to remember what you said to yourself or what someone else said to you or where you placed certain written messages that you now can't find. With this program you will know where you can find exactly what you need to know about where you want to and have to be, or where you have been, before you get and after you got there. Thus, ZX-Calendar will let you plan your time so that you will never have to worry about what is ahead or what came before, for you will always know, by using it, to never be caught astray by any time-frame.

**\$16.95**

**\$3.00 SHIPPING AND HANDLING/PROGRAM**

**A.F.R. SOFTWARE - 1605 Pennsylvania Avenue, No. 204 - Miami Beach, Florida 33139**  
DEALER INQUIRIES WELCOME (305) 531-6464 FLORIDIANS ADD SALES TAX